

TEST	IDEAL RANGE	ADJUSTMENT REQUIRED
Free Chlorine	1.0 - 3.0 ppm	Turn output dial up to increase, down to decrease -OR- increase or decrease pump filtration time.
pH	7.2 - 7.6	Too high - add muriatic acid Too low - add soda ash.
Alkalinity	80 - 120 ppm	Add baking soda to increase. Add acid as required to decrease.
Salt	2700 - 3400 ppm	Add salt as required to increase.
Stabilizer	60 - 80 ppm	Add cyanuric acid to increase.
Calcium	200 - 400 ppm	Add calcium to increase. Drain and add water to decrease.
Electrolytic Cell	inspect & clean	Refer to section in manual.

PRO LOGIC™

Automation and Chlorination



Operation Manual



for models

PL-PS-4
PL-PS-8
PL-PS-16

PL-PS-8-V
PL-PS-16-V

IMPORTANT SAFETY INSTRUCTIONS

When using this electrical equipment, basic safety precautions should always be followed, including the following:

- **READ AND FOLLOW ALL INSTRUCTIONS**
-  **WARNING: Disconnect all AC power during installation.**
-  **WARNING: Water in excess of 100 degrees Fahrenheit may be hazardous to your health.**
-  **WARNING: To reduce the risk of injury, do not permit children to use this product unless they are closely supervised at all times.**
- A green colored terminal marked “Earth Ground” is located inside the wiring compartment. To reduce the risk of electric shock, this terminal must be connected to the grounding means provided in the electric supply service panel with a continuous copper wire equivalent in size to the circuit conductors supplying the equipment.
- One bonding lug for US models (two for Canadian models) is provided on the external surface. To reduce the risk of electric shock, connect the local common bonding grid in the area of the swimming pool, spa, or hot tub to these terminals with an insulated or bare copper conductor not smaller than 8 AWG US / 6 AWG Canada.
- All field installed metal components such as rails, ladders, drains, or other similar hardware within 3 meters of the pool, spa or hot tub shall be bonded to the equipment grounding bus with copper conductors not smaller than 8 AWG US / 6 AWG Canada.
- **SAVE THESE INSTRUCTIONS**

LIMITED WARRANTY Goldline warrants its Aqua Rite, Aqua Rite Pro, Aqua Trol, Aqua Logic and Pro Logic products (products with Goldline part numbers starting with AQ-RITE-, AQ-RT-PRO, AQ-TROL-, AQ-LOGIC-, AQL-P-, AQL-PS-, AQL-CL-, PL-P-, PL-PS-, and HPC-2) to be free from defects in material or workmanship, under normal use and service:

For **three years** from the date of the initial system installation on private, residential swimming pools within the USA or Canada and **one year** from the date of initial system installation on commercial installations, installations outside of the USA or Canada and for any replacement parts or accessory products, provided they are installed in accordance with the Goldline installation instructions and specifications provided with the product. If written proof of the date of the initial system installation is not provided to Goldline, the manufacturing datecode on the Aqua Rite, Aqua Rite Pro, Aqua Trol, Aqua Logic and Pro Logic electronics unit will be the sole determinant of the date of the initial system installation.

For residential installations in USA or Canada: If a product is defective in workmanship or materials and is removed and returned freight prepaid within three (3) years after the date of the initial system installation, Goldline will, at its option, either repair or replace the defective product and return it freight prepaid.

For commercial installations, installations outside the USA and Canada, and accessory products and replacement parts: If a product is defective in workmanship or materials and is removed and returned freight prepaid within one (1) year after the date of the initial system installation, Goldline will, at its option, either repair or replace the defective product and return it freight prepaid.

Contact any Goldline dealer or contact Goldline at 61 Whitecap Drive, North Kingstown, RI 02852 for warranty service. The costs incurred in removal and/or reinstallation of the product are NOT covered under this warranty. Some states do not allow limitations on how long an implied warranty lasts, so the above limitation may not apply to you.

WARRANTY EXCLUSIONS:

1. Material supplied or workmanship performed by others in process of installation.
2. Damage resulting from improper installation including installation on pools larger than the product rating.
3. Problems resulting from failure to operate the product(s) in accordance with the recommended instructions contained in product’s owners manual(s).
4. Problems resulting from failure to maintain pool water chemistry in accordance with -the recommendations in the owners manual(s).
5. Problems resulting from tampering, accident, abuse, negligence, unauthorized repairs or alternations, fire, flood, lightning, freezing, external water, degradation of natural stone used in or immediately adjacent to a pool or spa, war or acts of God.

DISCLAIMER. THE EXPRESS LIMITED WARRANTY ABOVE CONSTITUTES THE ENTIRE WARRANTY OF GOLDLINE WITH RESPECT TO ITS POOL AUTOMATION AND CHLORINATION PRODUCTS AND IS IN LIEU OF ALL OTHER WARRANTIES, EXPRESSED OR IMPLIED, INCLUDING WARRANTIES OF MERCHANTABILITY OR FITNESS FOR A PARTICULAR PURPOSE. THIS WARRANTY GIVES YOU SPECIFIC LEGAL RIGHTS, AND YOU MAY ALSO HAVE OTHER RIGHTS WHICH VARY FROM STATE TO STATE. IN NO EVENT SHALL GOLDLINE BE RESPONSIBLE FOR ANY CONSEQUENTIAL, SPECIAL OR INCIDENTAL DAMAGES OF ANY NATURE WHATSOEVER, INCLUDING, BUT NOT LIMITED TO, PERSONAL INJURY, PROPERTY DAMAGE, DAMAGE TO OR LOSS OF EQUIPMENT, LOST PROFITS OR REVENUE, COSTS OF RENTING REPLACEMENTS, AND OTHER ADDITIONAL EXPENSES, EVEN IF THE SELLER HAD BEEN ADVISED OF THE POSSIBILITY OF SUCH DAMAGES. SOME STATES DO NOT ALLOW THE EXCLUSION OF LIMITATION OF INCIDENTAL OR CONSEQUENTIAL DAMAGES, SO THE ABOVE LIMITATION OR EXCLUSION MAY NOT APPLY TO YOU.

NO WHOLESALE, AGENT, DEALER, CONTRACTOR OR OTHER PERSON IS AUTHORIZED TO GIVE ANY WARRANTY ON BEHALF OF GOLDLINE.

THIS WARRANTY IS VOID IF THE PRODUCT HAS BEEN ALTERED IN ANY WAY AFTER LEAVING THE FACTORY.

Table of Contents

System Overview	Block Diagram.....	1
	Automation.....	1
	Chlorination.....	2
	Default Display.....	2
Manual System Operation	Output Names.....	3
	Filter Pump.....	3
	Lights and Aux Outputs.....	4
	Pool/Spa Valves.....	4
	Heaters.....	5
	System Off.....	5
	Service.....	5
Automatic System Operation (Programming)	Using the Programming Buttons.....	6
	Programming Menu Flow Chart.....	7
	Settings Menu.....	8
	Timers Menu.....	12
	Group Function.....	16
	Configuration Menu.....	18
	Maintenance Menu.....	33
Quick “How To” Guide	Operate the Spa - Manually.....	34
	Operate the Spa - Automatically.....	34
	Set the Heater Temperature.....	34
	Set the Chlorinator Output	34
	Start/Stop Superchlorination.....	35
	Program a Timeclock.....	35
	Program a Countdown Timer.....	35
	Enter/Exit Service Mode.....	36
Chlorinator Operation/ Water Chemistry	Saturation Index.....	37
	Salt Level.....	37
	Type of Salt.....	38
	How to Add or Remove Salt.....	38
System Maintenance	Servicing and Cleaning the Pro Logic Cell.....	41
	Winterizing.....	41
	Spring Startup.....	41
Troubleshooting & Diagnostic Information	Service Mode	42
	Check System Indicator.....	42
	Diagnostic Menu.....	44
	Chlorinator Diagnostics.....	44
	Instant Salt.....	45
	pH Display.....	45
	Flow Switch.....	45
	Cell, Water, Air, Solar Temperature.....	45
Software Revision.....	46	
Warranty	Pro Logic Warranty.....	48

System Overview

The Pro Logic is a multifunction pool controller used to fully manage your pool/spa system. The Pro Logic can control pumps, valves, lighting, heaters, and chlorination. Although the Pro Logic is easy to use, it is important to completely read through this operating manual before attempting to operate the control.

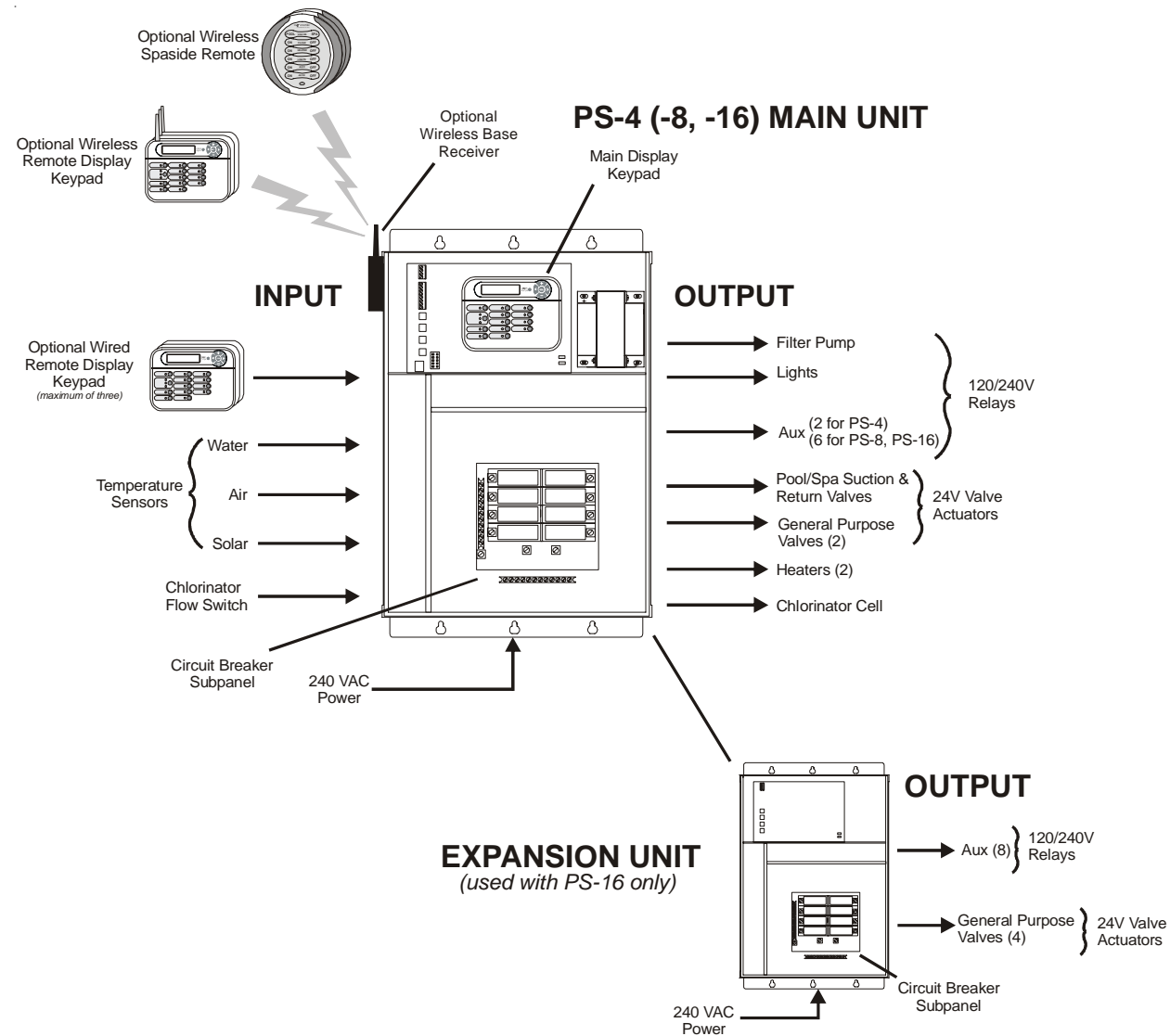

NOTE: This manual assumes that the Pro Logic has been wired and configured according to the Installation Manual. Aspects of the Pro Logic that pertain to system setup are not covered in this manual.

Automation

The PL-PS-4 (-8, -16) can control up to 4 (8, 16) high voltage (120/240V) pieces of equipment, up to 4 (8 for the PS-16) automatic valve actuators, and 2 conventional heaters plus a solar heater. Both manual and automatic (programmed) operation are available. All of the control functions can be programmed at a display/keypad which is part of the main unit (typically located near the pool equipment) or at one or more remote display/keypads.

Main Software Revision 2.40	+ - No function <> Move to previous/next menu item
Display Software remote-08 r3.10	+ - No function <> Move to previous/next menu item
Exp. Unit Software Revision 1.10	+ - No function <> Move to previous/next menu item
Chemistry Sense Software r1.00	+ - No function <> Move to previous/next menu item
Pool Filter Bridge Software r1.00	+ - No function <> Move to previous/next menu item
Pool Filter VSC Software r1.00	+ - No function <> Move to previous/next menu item
Spa Filter Bridge Software r1.00	+ - No function <> Move to previous/next menu item
Spa Filter VSC Software r1.00	+ - No function <> Move to previous/next menu item
RF Base Software r1.20 ID:1234	+ - No function <> Move to previous/next menu item
6B Spa Software Remote A r1.00	+ - No function <> Move to previous/next menu item
Digital Spa Software Remote B r1.00	+ - No function <> Move to previous/next menu item

If you call the Goldline Technical Service Dept. for assistance, they may ask for the software revisions of both the main unit and each of the display/keypads or other devices that are attached to the system. Note that it is possible that different display/keypads have different software revision levels. For this reason, it is advisable to check this diagnostic menu item on every display.

The Pro Logic periodically reverses the polarity of the voltage applied to the cell in order to automatically clean off any calcium deposits. It is important that you check the chlorinator operation in both polarities. To do this, press either the “+” or “-” buttons and the chlorinator will turn off, wait for 15 seconds and then turn on in the opposite polarity.

If a conventional or solar heater is operating, it is likely that the temperature of the water at the cell is higher than the pool/spa water temperature displayed on the Pro Logic default display.

Instant Salt
3200 PPM (+ = save)

+ Press to load the “Instant Salt” into the averaged salt display

<> Move to previous/next menu item

This display shows “Instant Salt” or “Instant Minerals” (if Chlor. Config. is set for “Display Minerals”). The “Instant Salt” is calculated based on the voltage, current (amps), and water temperature at the cell. This is different than the “average salt” value which is displayed as part of the default menu. There are a number of reasons why instant and average salt readings may differ. Some of these include salt having just been added to the pool and not yet thoroughly mixed, calcium buildup on the cell, and the cell aging.

if AQL-CHEM is used

pH 7.5 ON
ORP 700 mV ON

+ No function

<> Move to previous/next menu item

This display shows both pH and ORP levels/status when chemistry sensing is enabled via the Chemistry Configuration Wizard (requires the use of AQL-CHEM Sensing Kit). The Pro Logic will refer to these levels to determine how much chlorine to generate (ORP) and, if using an AQL-CHEM2 dispense kit, how much CO₂ or acid to dispense (pH). Refer to the AQL-CHEM manual for specific information about these levels as well as the recommended ranges.

Flow Switch
Flow

+ No function

<> Move to previous/next menu item

The current status of the flow switch is displayed. There is a short delay when transitioning from flow to no-flow and a longer delay on the transition from no-flow to flow. The delay time is displayed.

Cell Temp Sensor
77°F

+ No function

<> Move to previous/next menu item

Water Sensor
Open circuit

+ No function

<> Move to previous/next menu item

Spa Sensor
102°F

+ No function

<> Move to previous/next menu item

Air Sensor
94°F

+ No function

<> Move to previous/next menu item

Solar Sensor
Short circuit

+ No function

<> Move to previous/next menu item

NOTE: If Pool and Spa-Dual is selected, the solar sensor will display as “Spa Sensor” and the water sensor will display as “Pool Sensor”.

If the sensor appears to operating properly, then the temperature will be displayed. If this temperature is not correct then check the placement of the sensor. If the problem is not placement related, then the sensor will, most likely, require replacement. If the display is “Open Circuit” or “Short Circuit” then check the wiring to the sensor and also make sure that the wires are secure in the terminal block in the Aqua Logic main unit.

Chlorination

With the use of the optional AQL-CL chlorination kit, the Pro Logic is also an automatic chlorine generation system for pool and/or spa sanitization. If enabled (see Configuration Menu), this operation requires a low concentration of salt (sodium chloride) in the pool/spa water. The Pro Logic automatically converts the salt into free chlorine which kills bacteria and algae in the pool/spa. Chlorine will revert back to sodium chloride after killing bacteria. These reactions will continuously recycle, virtually eliminating the need to add sanitizing chemicals to your pool/spa. The only time you may need to add more salt to the pool/spa is when water is replenished due to backwashing, draining, or splashing (not evaporation).

The Pro Logic is designed to handle the purification needs of most residential swimming pools up to 40,000 gallons (150,000 liters), or the needs of most commercial pools up to 25,000 gallons (95,000 liters). Check local codes for other restrictions. The actual amount of chlorination required to properly sanitize a pool varies due to bather load, rainfall, temperature, and the pool’s cleanliness.

For pools larger than 40,000 gallons, the Pro Logic can control one or more Goldline Aqua Rite chlorinators to supplement chlorine production.

NOTE: Before installing this product as part of a saline water purification system in a pool or spa using natural stone for coping or for immediately adjacent patios/decking, a qualified stone installation specialist should be consulted regarding the appropriate type, installation, sealant (if any) and maintenance of stone used around a saline pool with electronic chlorine generator in your particular location and circumstances.

Default Display

Turn power on at the main panel and turn the Pro Logic control power circuit breaker on. The keypad will show the default display. The default display alternates between the day/time, air and pool (or spa) temperature, pool/spa sanitizer setting, and salt level. Under certain circumstances, additional displays may be added to the default menu to inform you about system operation. Refer to the Programming Menu Flowchart on page 7 to view all possible displays. The Pro Logic will automatically scroll through all of the available default menu displays or you can press “<” or “>” to manually scroll.

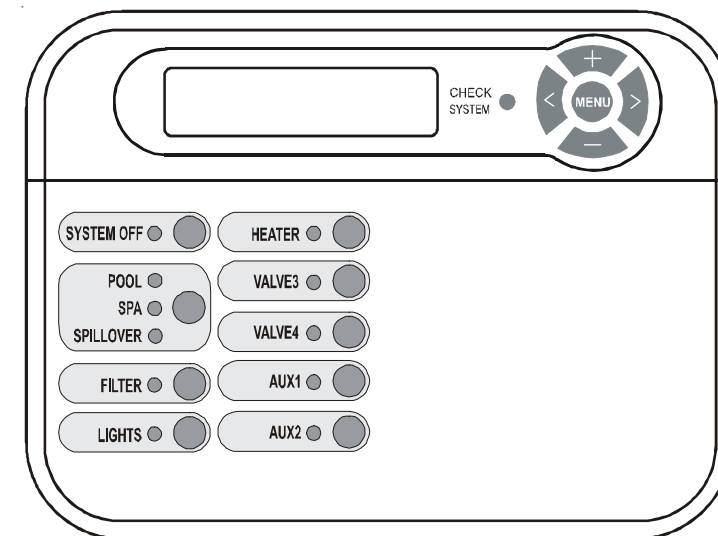

Optional Remote Display/keypad shown--the display keypad on the main control unit will have a “Service” button in the upper left corner instead of the “System Off” button.

Manual System Operation

While the main objective of the Pro Logic is to automate the operation of your pool/spa system, there may be certain times when you want to override the automatic operation and control the equipment manually. To operate the pool equipment manually while keeping the automation active, perform the following procedures. Note that if you turn a relay on manually, it will remain on until either you turn it off manually, or the next time the programmed automatic operation would normally turn that relay off. Example: the filter pump is programmed to run from 9:00A to 5:00P daily. If you turn the filter pump on manually at 8:00PM, it will run continuously until the next day at 5:00PM at which time it will turn off and follow the normal program from then on. Manually turning off a relay works in a similar fashion.

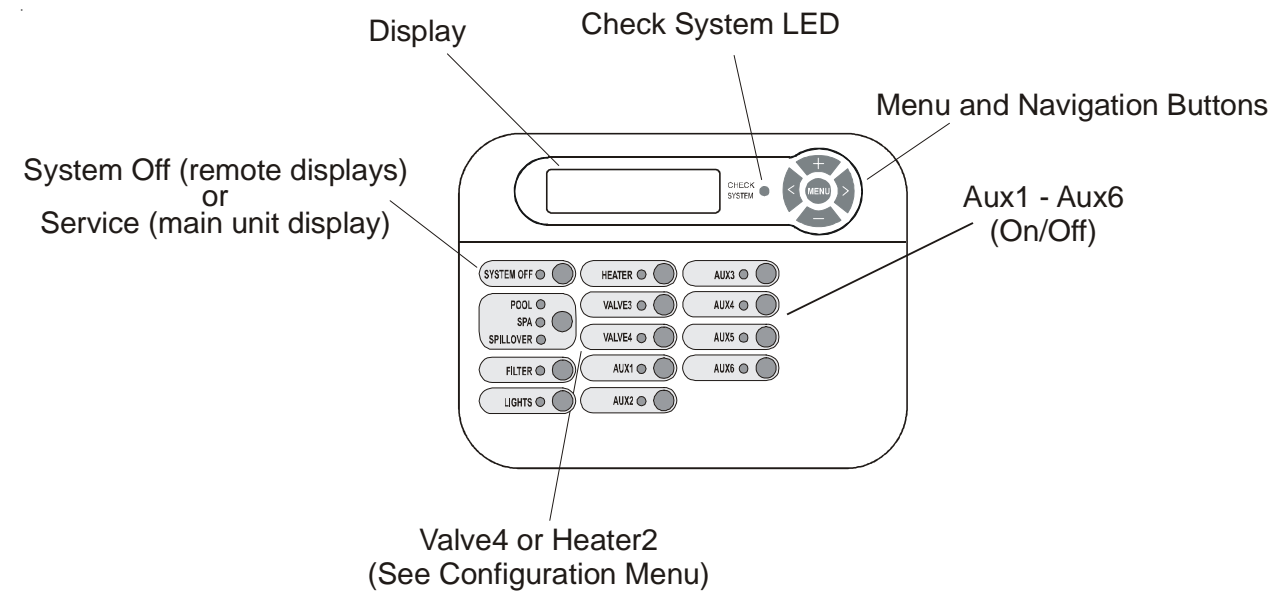

Output Names

The Pro Logic is shipped from the factory with each output labeled with a generic name (e.g. AUX1, VALVE3, etc.). One of the features in the software (see Configuration Menu, page 16) is that each output can be assigned a new name that is more descriptive of the equipment being controlled. This makes it much easier to operate all of the equipment on your pool without having to memorize what each output controls. Insert name labels are also provided to be placed next to each display pushbutton. Since there is no way to know how your particular system is configured, this manual will use the original generic names for each output.

Pool Filter Pump

The pool filter pump can be manually operated whether in Standard (single pump) or Dual Equipment (separate pumps for both pool and spa) mode. When in Standard mode, the display will refer to the pool filter pump as "FILTER". When in Dual Equipment mode, the display will read "POOL FILTER".

Single Speed Filter Pump: If the pump is currently off, press the "FILTER" button to turn on the pump. Pressing the "FILTER" button again will turn off the pump. However, if there is a heater in the system, and it is operating, and the "Heater Cooldown" feature is enabled (Configuration Menu) then: when you press the "FILTER" button to turn off the filter, only the heater will turn off, the "FILTER" LED will flash and the display will indicate "Heater Cooldown". At this point the filter pump will automatically turn off after 5 minutes of heater cooldown operation. If you want to override the heater cooldown, simply press the "FILTER" button again to turn off the filter pump.

- **ORP Probe Error** -- If the CSM indicates that there is a problem with the ORP probe.
- **ORP Low - Check Chlor** -- If an ORP level of 350mV or less is detected. Check the chlorinator for proper operation.
- **ORP High - Check Chlor** -- If an ORP level of 950mV or higher is detected. Check the chlorinator for proper operation.
- **ORP High - Chlor Off** -- If an ORP level of 950mV or higher is detected and the chlorine feed mode is ORP Auto Sensing, the chlorinator has been turned off. Check the chlorinator for proper operation.
- **ORP Timeout -Chlor Off** -- If the unit has been chlorinating for more than the selected sanitizer timeout without reaching the desired level, the chlorinator has been turned off. Press the "+" button to reset the alarm and resume chlorination.

For helpful troubleshooting information on any of these issues, go to the Diagnostic Menu and then scroll through the various items until you see the cause for the "CHECK SYSTEM" LED being illuminated.

Diagnostic Menu

To enter the Diagnostic Menu, press the "Menu" button repeatedly until the display shows "Diagnostic Menu". At this point, you can use either the "<" or ">" buttons to scroll through the various menu items which are described below:

+23.45	+6.75A	+-	Press to switch chlorinator operation to opposite polarity (15 second delay)
84°F	3200PPM	<>	Move to previous/next menu item

+/- 23.45V is the voltage applied to the chlorinator cell
 +/-6.75A is the current (amps) through the cell
 84°F is the water temperature at the cell
 3200PPM is the "instant" salt level at this time

For the chlorinator to be operating, several other things must be happening: the filter pump must be running, the flow switch must be detecting flow, the chlorinator setting must be set greater than 0%, the water temperature at the cell must be between 50°F and 140°F, and the salt level must be within the operating range. If any of these conditions are not met, the chlorinator diagnostic display will tell you the reason. It's possible to have more than one reason, in which case after you rectify what was displayed the first time, a second display will appear.

If the current (amps) display is 0.00A, then the chlorinator is operating normally but is in the off part of its normal operating cycle. Simply press either the "+" or "-" key to start a new cycle.

- **Solar/Spa sensor** -- if the solar (if solar is enabled), (Configuration Menu/Solar Config.) or spa (if Dual Equipment) sensor is either an open or short circuit.
- **Chlorinator Cell sensor** -- if the chlorinator function enabled (Configuration Menu/Chlorinator) and the cell sensor is either an open or short circuit.
- **PS-16 Communication Error** -- if an PL-PS-16 and the Expansion Unit is not responding.
- **Low Volts** -- if the chlorinator cell voltage is too low.
- **No Cell Power** -- if no chlorinator cell power is detected on the printed circuit board.
- **Chk Flow Switch** -- if the flow switch input is invalid.
- **Cell Power Error** -- if a chlorinator cell power error is detected on the printed circuit board.
- **No Flow-Filter Pump** -- if the filter pump is on and the flow switch indicates no flow for 15 minutes or more.
- **Cell Missing** -- if the chlorinator is enabled but no cell is detected.
- **Pool Bridge Comm** -- If variable speed is selected for the Pool Filter and the VSC interface is not responding.
- **Pool VSC Comm** -- If variable speed is selected for the Pool Filter and the Hayward VSC is not responding.
- **Pool VSC Err: x** -- If variable speed is selected for the Pool Filter and the Hayward VSC is indicating and error. x is the same decimal error displayed by the VSC itself.
- **Spa Bridge Comm** -- If variable speed is selected for the Dual Equipment Spa Filter and the VSC interface is not responding.
- **Spa VSC Comm** -- If variable speed is selected for the Dual Equipment Spa Filter and the Hayward VSC is not responding.
- **Spa VSC Err: x** -- If variable speed is selected for the Dual Equipment Spa Filter and the Hayward VSC is indicating and error. x is the same decimal error displayed by the VSC itself.
- **CSM Comm Error:** -- If Chemistry Sensing is enabled and the Chemistry Sense Module (CSM) is not responding.
- **pH Probe Error** -- If the CSM indicates that there is a problem with the pH probe.
- **pH Low - Check Feeder** -- If a pH level of 6.9 or less is detected, check the feeder for proper operation
- **pH High - Check Feeder** -- If a pH level of 8.1 or higher is detected, check the chemical supply and the feeder for proper operation
- **pH Timeout - Check Feeder** -- If the unit has been dispensing pH for more than the selected timeout without reaching the desired level. Check the chemical supply and the feeder. If both are OK, the timeout may need to be increased. Press the “+” button to reset the alarm and resume dispensing.
- **pH Calibration Error** -- When using the pH Calibration Wizard and the entered test result was different from the measured pH level by ± 1.0 or more. The pH probe may need to be cleaned or replaced.

Two Speed or Variable Speed Filter Pump: If the pump is currently off, simply press the “FILTER” button to turn on high speed operation of the filter pump. The “Filter” LED will illuminate continuously. Pressing the “FILTER” button again will switch to low speed operation and the “FILTER” LED will flash. Note that if the pump has been off for more than 30 seconds, it will run at high(est) speed for 3 minutes regardless of selection. This high speed operation helps allow the pump to prime and establish normal water flow.

Freeze Protection: This function protects the pool, plumbing, and equipment against freeze damage. If Freeze Protection is enabled and the AIR temperature sensor falls below the preset freeze protection temperature (see Filter Configuration), the Pro Logic will turn on the filter pump to circulate the water.

Spa Filter Pump (when using Dual Equipment)

Single Speed Filter Pump: If the pump is currently off, press the “AUX1” button to turn on the pump. Pressing the “AUX1” button again will turn off the pump. However, if there is a heater in the system, and it is operating, and the “Heater Cooldown” feature is enabled (Configuration Menu) then: when you press the “AUX1” button to turn off the filter, only the heater will turn off, the Filter LED will flash and the display will indicate “Heater Cooldown”. At this point the filter pump will automatically turn off after 5 minutes of heater cooldown operation. If you want to override the heater cooldown, simply press the “AUX1” button again to turn off the filter pump.

Two Speed or Variable Speed Spa Filter Pump: If the pump is currently off, simply press the “AUX1” button to turn on high speed operation of the filter pump. The “AUX1” LED will illuminate continuously. Pressing the “AUX1” button again will switch to low speed operation and the “AUX1” LED will flash. Note that if the pump has been off for more than 30 seconds, it will run at high(est) speed for 3 minutes regardless of selection. This high speed operation helps allow the pump to prime and establish normal water flow.

Freeze Protection: This function protects the pool, plumbing, and equipment against freeze damage. If Freeze Protection is enabled and the AIR temperature sensor falls below the preset freeze protection temperature, the Pro Logic will turn on the spa filter pump to circulate the water.

Lights and Aux Outputs

Standard Relay: Manual operation of all relays (LIGHTS, AUX1 and AUX2 for a PS-4 model, LIGHTS, AUX1 - AUX6 for a PS-8 model, or LIGHTS, AUX1 - AUX14 for a PS-16 model) is identical. Assuming that the relay is currently off, simply press the appropriate button to turn on the relay. If the relay does not turn on, it probably is due to the “interlock” feature (which was set up in the Configuration Menu) being activated that requires the filter pump to be running and the valves to be in the pool-only position. This protects pumps and other equipment from possible damage. If the controlled output is on, pressing the appropriate button again will turn off the relay. Manual turn off is disabled if the “Freeze Protection” feature is enabled and the air temperature is less than the selected freeze temperature threshold.

Dimmer Relay: If Lights or an Aux output is configured as a dimmer, pressing the corresponding button will generate a temporary display which shows the dimmer output level (Off - On 100%). Pushing the “+” or “-” button changes the level in increments of 20%. When the desired output level is displayed, press the corresponding button again to turn off the display and return to normal operation. When the Lights or Aux output comes on again (either manually or automatically), the dimmer output level will be the same as the last time that it was set.

Pool/Spa Valves

Pool-only or Spa-only systems: The POOL/SPA/SPILLOVER button has no function.

Standard Pool and Spa systems without spa spillover: In pool-only mode (“POOL” LED illuminated), press the “POOL/SPA/SPILLOVER” button to switch to spa-only operation (“SPA” LED illuminated). Pressing the “POOL/SPA/SPILLOVER” button again will switch back to pool-only. Note that the filter pump will turn off while the pool/spa valves are turning.

Standard Pool and Spa systems with spa spillover: When currently in the pool-only mode (“POOL” LED illuminated), press the “POOL/SPA/SPILOVER” button to switch to spa-only operation (“SPA” LED illuminated). Press the button again to switch to spa spillover operation (“SPILOVER” LED illuminated). Pressing the “POOL/SPA/SPILOVER” button again will switch back to pool-only mode. Note that the filter pump will turn off while the pool/spa valves are turning.

Dual Equipment Pool and Spa systems without spa spillover: The POOL/SPA/SPILOVER button has no function. The “POOL” LED will always be illuminated.

Dual Equipment Pool and Spa systems with spa spillover: When currently in the separate Pool and Spa loops mode (“POOL” LED illuminated) and the Spa Filter is off, press the POOL/SPA/SPILOVER button to switch to spa spillover operation (“SPILOVER” LED illuminated). Press the POOL/SPA/SPILOVER button again to return to the separate Pool and Spa loops mode of operation. Note that the Pool Filter pump will shut off while the pool/spa return valve is turning. The system will automatically switch out of spillover whenever the spa filter pump is turned on.

Note: For Dual Equipment Pool and Spa systems, there is no Spa Only mode.

Heaters

This description applies to Heater1 and to Heater2, if programmed (note that the function of the Valve4 button changes to Heater2 when Heater2 is enabled). Pressing the “HEATER” button causes the Pro Logic to switch the heater control output between a “forced off” state and a normal, automatic thermostat control operating state.

System Off

Each remote display/keypad has a red “SYSTEM OFF” button on the upper left corner of the keypad. Pressing this button will turn all outputs off and they will remain off, regardless of any programmed control logic, until either the “SYSTEM OFF” button (on any remote display/keypad) is pressed again or the “SERVICE” button is pressed on the display/keypad at the main unit. The red “SYSTEM OFF” LED will illuminate to indicate that all outputs and being forced off.

 **WARNING: pressing the “SYSTEM OFF” button overrides any programmed freeze protection and may cause damage to your system in freezing conditions.**

Service

The main unit keypad has a “SERVICE” key. This button is used primarily during servicing of the pool equipment. If you want to completely disable the automatic operation and operate the system manually, you can put the system into Service or Service-Timed mode by pressing the “SERVICE” button. Pressing the “SERVICE” button once will switch the system into service mode which means that all automatic functions are disabled, and the remote display/keypads are disabled (except for manual turn off for emergencies). The red “SERVICE” LED will be illuminated and the Pro Logic will remain in this mode of operation until manually taken out of service mode.

Pressing the “SERVICE” button again will cause the Pro Logic to switch to service-timed mode which is very similar to service mode, except that the Pro Logic will automatically return to normal operation after 3 hours. During service timed operation, the “SERVICE” LED will flash and the time remaining will be displayed on the remote display/keypad(s).

Pressing the “SERVICE” button again, will return the Pro Logic to normal (automatic) operation. See Troubleshooting/Diagnostic Information for more information about the service modes.

Troubleshooting and Diagnostic Information

The Pro Logic provides 2 different tools to aid in troubleshooting any problems that may occur in your pool and/or spa system. The Service mode will allow you to disable automatic operation and manually control most of the equipment (the heater and general purpose Valve3 output are the exceptions). The Diagnostic Menu will provide some detailed information regarding system operation.

While both of the features are primarily intended for the use of the professional service technician, their function is fully explained below. If you believe your system is not operating properly or have questions regarding the operation, call the Goldline Technical Service Dept. from Monday through Friday, 8AM to 8PM EST at 908-355-7995.

Service Mode

The main unit keypad has a SERVICE button that is used primarily during servicing of the pool equipment.

If you want to completely disable the automatic operation and operate the system manually, you can put the system into Service or Service-Timed mode by pressing the “Service” button. Pressing the “SERVICE” button once will switch the system into service mode which means that all automatic functions are disabled, the optional remote display/keypads are disabled (except for manual turn off for emergencies). The outputs can be manually controlled by pressing the buttons on the local display/keypad. The red “SERVICE” LED will be illuminated and the Pro Logic will remain in this mode of operation until manually taken out of service mode.

Pressing the “SERVICE” button again will cause the Pro Logic to switch to service-timed mode which is very similar to service mode, except that the Pro Logic will automatically return to normal operation after 3 hours. During service timed operation, the “SERVICE” LED will flash and the time remaining will be displayed on the remote display/keypad(s).

Pressing the “SERVICE” button again, will return the Pro Logic to normal (automatic) operation.

Check System Indicator

The “CHECK SYSTEM” LED will alert you when the Pro Logic detects any of the following conditions that are abnormal and require attention for optimal operation of your pool. Press “<” or “>” to view all of the existing “Check System” conditions.

- **Inspect Cell** -- for optimum operation, you will need to inspect the Pro Logic chlorinator cell approximately every 3 months and clean the cell if necessary. The Pro Logic will automatically remind you when it is time and display “Inspect Cell, + to reset” as part of the rotating Default Menu. Clean the cell and then press the “+” button during the “Inspect Cell” display to reset the timer.
- **Low Salt/Minerals or Very Low Salt/Minerals** -- when the salt is too low the Pro Logic will generate less chlorine and the life of the cell is degraded. Check the cell and clean if necessary before adding salt.
- **High Salt/Amps/Minerals** -- the Pro Logic will stop generating chlorine under certain high salt conditions in order to protect the internal electronics from damage. The only way to lower the salt level is to partially drain the pool and add fresh water.
- **Water/Pool Sensor** -- if the water or pool (if Dual Equipment) sensor is either an open or short circuit.
- **Air sensor** -- if the freeze protection feature is enabled (Configuration Menu/ Filter Config.) and the air sensor is either an open or short circuit.

System Maintenance

To maintain maximum performance, it is recommended that you open and visually inspect the cell every 3 months or after cleaning your filter. The Pro Logic will remind you to do this by displaying the message “Inspect/Clean Cell” after approximately 500 hours of operation.

The Pro Logic electrolytic cell has a self cleaning feature incorporated into the electronic control’s logic. In most cases this self cleaning action will keep the cell working at optimum efficiency. In areas where water is hard (high mineral content) or in pools where the water chemistry has been allowed to get “out of balance”, the cell may require periodic cleaning.

Servicing and Cleaning the Pro Logic Cell

Turn off power to the Pro Logic before removing the electrolytic cell. Once removed, look inside the cell and inspect for scale formation (light colored crusty or flaky deposits) on the plates and for any debris which has passed through the filter and caught on the plates. If no deposits are visible, reinstall. If deposits are seen, use a high pressure garden hose and try to flush the scale off. If this is not successful, use a plastic or wood tool (do not use metal as this will scratch the coating off the plates) and scrape deposits off of plates. Note that a buildup on the cell indicates that there is an unusually high calcium level in the pool (old pool water is usually the cause). If this is not corrected, you may have to periodically clean the cell. The simplest way to avoid this is to bring the pool chemistry to the recommended levels as specified.

Mild Acid Washing: Use only in severe cases where flushing and scraping will not remove the majority of deposits. To acid wash, turn off power to Pro Logic. Remove cell from piping. In a clean plastic container, mix a 2:1 solution of water to muriatic acid (one gallon of water to two quarts of muriatic acid). ALWAYS ADD ACID TO WATER - NEVER ADD WATER TO ACID. Be sure to wear rubber gloves and appropriate eye protection. The level of the solution in the container should just reach the top of the cell so that the wire harness compartment is NOT submerged. It may be helpful to coil the wiring before immersing the cell. The cell should soak for a few minutes and then rinse with a high pressure garden hose. If any deposits are still visible, repeat soaking and rinsing. Replace cell and inspect again periodically.

Winterizing

The Pro Logic electrolytic cell and flow detection switch will be damaged by freezing water just as your pool plumbing would. In areas of the country which experience severe or extended periods of freezing temperatures, be sure to drain all water from the pump, filter, and supply and return lines before any freezing conditions occur. The electronic control is capable of withstanding any winter weather and should not be removed.

If you are in an area that only experiences occasional freezing conditions, your Pro Logic system may be set up to circulate the pool water whenever the air sensor drops to 38°F. Make sure the air sensor is recording the correct temperature and is NOT located in the direct sunlight to ensure proper freeze protection operation.

Spring Start-up

When first starting the pool in the spring time, it is highly recommended that you temporarily set the pool and spa chlorinator settings (Settings Menu/Pool Sanitizer & Spa Sanitizer) to 0% (off) and then manually shock the pool with any chlorine based shock product and balance the pool water chemistry per the levels indicated in the Chlorinator Operation section. Make sure to check the salt and stabilizer levels and bring them up to the recommended levels. Your local Authorized Goldline Dealer or pool store can recommend the best chemical treatment for your pool. After the water is clear and balanced, then go back and adjust the pool and spa chlorinator settings to the appropriate levels. Test the pool chlorine level weekly and adjust the chlorinator settings up or down accordingly.

It is usually a good idea to also inspect the cell and clean if necessary at the start of the season. See instructions above.

Automatic System Operation

The Pro Logic controls most of your pool equipment automatically in order to minimize the time spent working on your pool. Most of the pool equipment can be programmed to operate on a timeclock basis. In addition, the desired pool and spa temperatures and pool and spa chlorinator settings can be programmed. This section will guide you on how to program the automatic operation for each function.



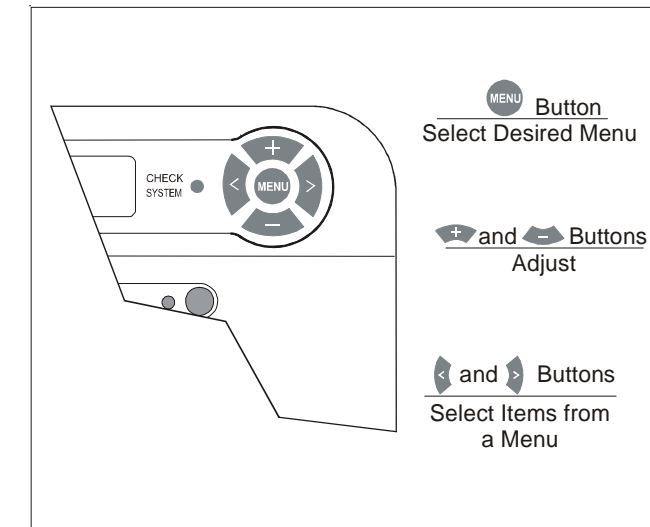

The programming of automatic functions can be performed at either the main display/keypad located at the pool equipment pad or the in-home remote display/keypad.

Using the programming buttons

There are 5 buttons on each keypad that are used for programming (refer to diagram).



There are 4 steps to programming any function:

-  Press the “MENU” button to get to the desired menu. Multiple pushes of the button will rotate through all 6 menus and return to the starting point.
-  Press either key to scroll through the various items in the selected menu. Multiple pushes of the button will rotate through all menu items and return to the starting point. Only menu items that are applicable to your pool will appear. (Example: if you don’t have a spa, then no spa related menu items will appear).
-  Once a menu item has been selected above, the current setting/selection will appear (flashing) on the display. Use the “+” and/or “-” keys to change this selection. Sometimes “+” and “-” will adjust a value up or down (example: heater temperature setting or timeclock on/off time). In this case, pushing the “+” or “-” will change the value by one increment and holding the “+” or “-” button in for more than one second will make the values auto scroll. In other cases, the “+” and “-” may toggle between 2 options (example: turning superchlorination ON or OFF).
-  After you have adjusted the item to the desired value, simply move on to the next menu item to “lock in” your new setting. The Pro Logic memory will maintain the setting, even if power is removed for an extended period.

Programming Menu Flowchart

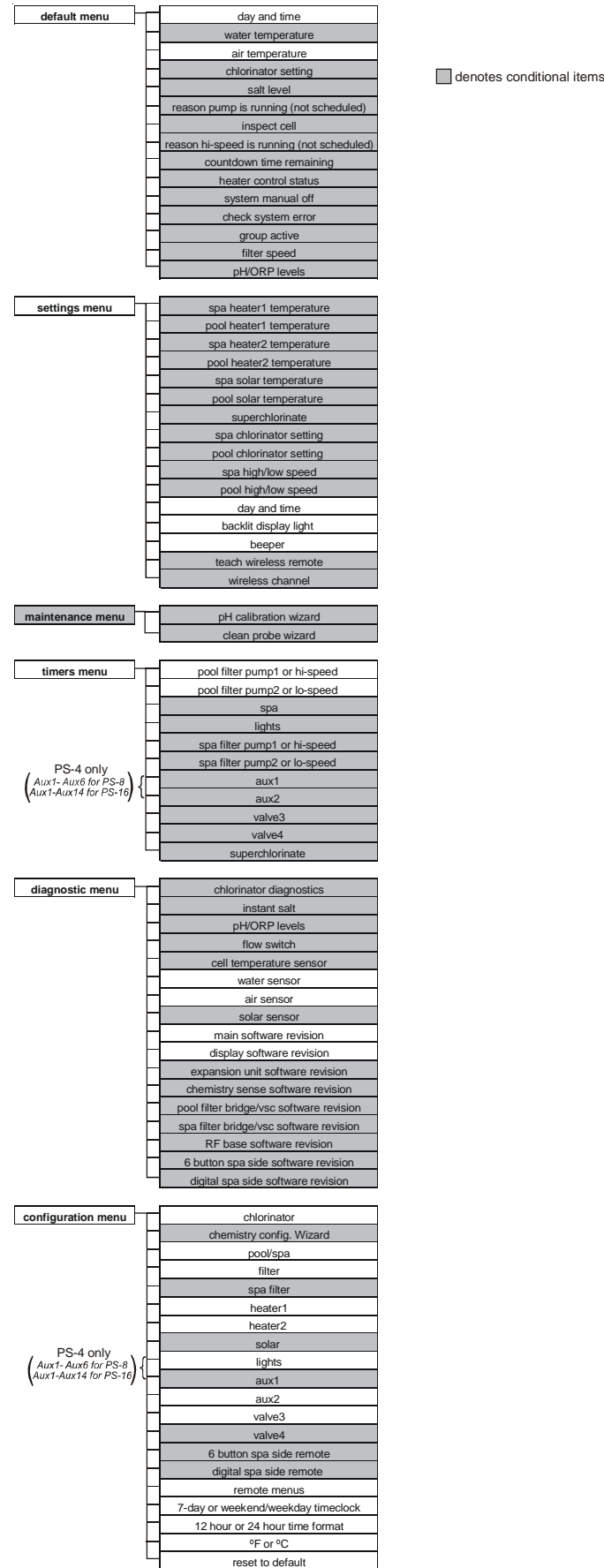

POUNDS and (Kg) OF STABILIZER (CYANURIC ACID) NEEDED FOR 80 PPM

Current Stabilizer Level (ppm)	Gallons and (Liters) of Pool/Spa water																
	8,000 (30000)	10,000 (37500)	12,000 (45000)	14,000 (52500)	16,000 (60000)	18,000 (67500)	20,000 (75000)	22,000 (82500)	24,000 (90000)	26,000 (97500)	28,000 (105000)	30,000 (112500)	32,000 (120000)	34,000 (127500)	36,000 (135000)	38,000 (142500)	40,000 (150000)
0 ppm	5.3 (3.6)	6.7 (4.3)	8.0 (4.3)	9.4 (4.3)	10.7 (4.9)	12.0 (5.4)	13.4 (6.1)	14.7 (6.7)	16.0 (7.3)	17.3 (7.9)	18.7 (8.5)	20.0 (9.1)	21.3 (9.7)	22.7 (10.3)	24.0 (10.9)	25.3 (11.5)	26.7 (12.0)
10 ppm	4.7 (3.2)	5.8 (3.7)	7.0 (3.2)	8.2 (3.7)	9.4 (4.3)	10.5 (4.8)	11.7 (5.3)	12.9 (5.9)	14.0 (6.4)	15.2 (6.9)	16.4 (7.4)	17.2 (8.0)	18.7 (8.5)	19.8 (9.0)	21.0 (9.5)	22.2 (10.0)	23.3 (10.5)
20 ppm	4.0 (2.7)	5.0 (3.2)	6.0 (2.7)	7.0 (3.2)	8.0 (3.6)	9.0 (4.2)	10.0 (4.5)	11.0 (5.0)	12.0 (5.4)	13.0 (5.9)	14.0 (6.4)	15.0 (6.8)	16.0 (7.2)	17.0 (7.7)	18.0 (8.1)	19.0 (8.6)	20.0 (9.0)
30 ppm	3.3 (2.3)	4.2 (2.7)	5.0 (2.3)	5.9 (2.7)	6.7 (3.0)	7.5 (3.4)	8.4 (3.8)	9.2 (4.2)	10.0 (4.5)	10.8 (4.9)	11.7 (5.2)	12.5 (5.6)	13.3 (6.0)	14.2 (6.3)	15.0 (6.7)	15.8 (7.1)	16.7 (7.5)
40 ppm	2.7 (1.8)	3.3 (2.1)	4.0 (1.8)	4.7 (2.1)	5.4 (2.4)	6.0 (2.7)	6.7 (3.0)	7.4 (3.3)	8.0 (3.6)	8.7 (3.9)	9.3 (4.2)	10.0 (4.5)	10.7 (4.8)	11.3 (5.1)	12.0 (5.4)	12.7 (6.0)	13.3 (6.0)
50 ppm	2.0 (1.4)	2.5 (1.6)	3.0 (1.4)	3.5 (1.6)	4.0 (1.8)	4.5 (2.0)	5.0 (2.2)	5.5 (2.5)	6.0 (2.7)	6.5 (2.9)	7.0 (3.2)	7.5 (3.4)	8.0 (3.6)	8.5 (3.9)	9.0 (4.1)	9.5 (4.3)	10.0 (4.5)
60 ppm	1.3 (0.9)	1.7 (1.1)	2.0 (0.9)	2.3 (1.1)	2.7 (1.2)	3.0 (1.4)	3.3 (1.5)	3.7 (1.7)	4.0 (1.8)	4.3 (2.0)	4.7 (2.1)	5.0 (2.3)	5.3 (2.4)	5.7 (2.6)	6.0 (2.7)	6.3 (2.8)	6.7 (3.0)
70 ppm	0.7 (0.45)	0.8 (0.54)	1.0 (0.45)	1.2 (0.54)	1.4 (0.64)	1.5 (0.68)	1.7 (0.77)	1.8 (0.82)	2.0 (0.91)	2.2 (0.91)	2.3 (1.01)	2.5 (1.12)	2.7 (1.22)	2.8 (1.33)	3.0 (1.44)	3.2 (1.54)	3.3 (1.65)
80 ppm	0.0	0.0	0.0	0.0	0.0	0.0	0.0	0.0	0.0	0.0	0.0	0.0	0.0	0.0	0.0	0.0	0.0

POUNDS and (Kg) OF SALT NEEDED FOR 3200 PPM

Current salt level ppm	Gallons and (Liters) of Pool/Spa water																
	8,000 (30,000)	10,000 (37,500)	12,000 (45,000)	14,000 (52,500)	16,000 (60,000)	18,000 (67,500)	20,000 (75,000)	22,000 (82,500)	24,000 (90,000)	26,000 (97,500)	28,000 (105,000)	30,000 (112,500)	32,000 (120,000)	34,000 (127,500)	36,000 (135,000)	38,000 (142,500)	40,000 (150,000)
0	213 (97)	267 (121)	320 (145)	373 (170)	427 (194)	480 (218)	533 (242)	587 (267)	640 (291)	693 (315)	747 (339)	800 (364)	854 (388)	907 (412)	960 (436)	1013 (460)	1067 (484)
200	200 (91)	250 (114)	300 (136)	350 (159)	400 (182)	450 (205)	500 (227)	550 (250)	600 (273)	650 (295)	700 (318)	750 (341)	800 (363)	850 (385)	900 (408)	950 (430)	1000 (453)
400	187 (85)	233 (106)	280 (127)	327 (148)	373 (170)	420 (191)	467 (212)	513 (233)	560 (255)	607 (276)	653 (297)	700 (318)	747 (339)	793 (360)	840 (382)	887 (403)	933 (424)
600	173 (79)	217 (98)	260 (118)	303 (138)	347 (158)	390 (177)	433 (197)	477 (217)	520 (236)	563 (256)	607 (276)	650 (297)	693 (317)	737 (337)	780 (358)	823 (378)	867 (398)
800	160 (73)	200 (91)	240 (109)	280 (127)	320 (145)	360 (164)	400 (182)	440 (200)	480 (218)	520 (236)	560 (255)	600 (273)	640 (291)	680 (310)	720 (328)	760 (346)	800 (364)
1000	147 (67)	183 (83)	220 (100)	257 (117)	293 (133)	330 (150)	367 (167)	403 (183)	440 (200)	477 (217)	513 (233)	550 (250)	587 (267)	623 (283)	660 (300)	697 (317)	733 (333)
1200	133 (61)	167 (76)	200 (91)	233 (106)	267 (121)	300 (136)	333 (152)	367 (167)	400 (182)	433 (197)	467 (212)	500 (227)	533 (243)	567 (258)	600 (274)	633 (289)	667 (304)
1400	120 (55)	150 (68)	180 (82)	210 (95)	240 (109)	270 (123)	300 (136)	330 (150)	360 (164)	390 (177)	420 (191)	450 (205)	480 (218)	510 (232)	540 (246)	570 (259)	600 (263)
1600	107 (48)	133 (61)	160 (73)	187 (85)	213 (97)	240 (109)	267 (121)	293 (133)	320 (145)	347 (158)	373 (170)	400 (182)	427 (195)	453 (207)	480 (219)	507 (231)	533 (243)
1800	93 (42)	117 (53)	140 (64)	163 (74)	187 (85)	210 (95)	233 (106)	257 (117)	280 (127)	303 (138)	327 (148)	350 (159)	373 (169)	397 (180)	420 (190)	443 (201)	467 (211)
2000	80 (36)	100 (45)	120 (55)	140 (64)	160 (73)	180 (82)	200 (91)	220 (100)	240 (109)	260 (118)	280 (127)	300 (136)	320 (145)	340 (154)	360 (163)	380 (172)	400 (181)
2200	67 (30)	83 (38)	100 (45)	117 (53)	133 (61)	150 (68)	167 (76)	183 (83)	200 (91)	217 (98)	233 (106)	250 (114)	267 (121)	283 (129)	300 (137)	317 (144)	333 (152)
2400	53 (24)	67 (30)	80 (36)	93 (42)	107 (48)	120 (55)	133 (61)	147 (67)	160 (73)	173 (79)	187 (85)	200 (91)	213 (98)	227 (104)	240 (110)	253 (117)	267 (123)
2600	40 (18)	50 (23)	60 (27)	70 (32)	80 (36)	90 (41)	100 (45)	110 (50)	120 (55)	130 (59)	140 (64)	150 (68)	160 (73)	170 (77)	180 (81)	190 (86)	200 (90)
2800	27 (12)	33 (15)	40 (18)	47 (21)	53 (24)	60 (27)	67 (30)	73 (33)	80 (36)	87 (39)	93 (42)	100 (45)	107 (48)	113 (51)	120 (54)	127 (57)	133 (60)
3000	13 (6)	17 (8)	20 (9)	23 (11)	27 (12)	30 (14)	33 (15)	37 (17)	40 (18)	43 (20)	47 (21)	50 (23)	53 (24)	57 (26)	60 (27)	63 (29)	67 (30)
3200	Ideal	Ideal	Ideal	Ideal	Ideal	Ideal	Ideal	Ideal	Ideal	Ideal	Ideal	Ideal	Ideal	Ideal	Ideal	Ideal	Ideal
3400	OK	OK	OK	OK	OK	OK	OK	OK	OK	OK	OK	OK	OK	OK	OK	OK	OK
3600+	Dilute	Dilute	Dilute	Dilute	Dilute	Dilute	Dilute	Dilute	Dilute	Dilute	Dilute	Dilute	Dilute	Dilute	Dilute	Dilute	Dilute

The Pro Logic’s six main menus have many items in each that allow you to customize the operation of your pool/spa equipment. The chart on the previous page shows the Pro Logic’s six menus as well as each menu’s specific settings.

The Default Menu is a series of informative displays (temperatures, salt levels, chlorinator settings, etc.) with nothing to set. The Pro Logic will automatically switch to the default menu when no keys have been pressed for 2 minutes and will then scroll through each display.

The Settings Menu and the Timers Menu are the menus you will be using most often to adjust the operation of your pool. The Configuration Menu is used when the system is installed and defines what equipment is connected to each output and the operational logic that will control the equipment. This menu is normally “locked” and should only be used by a pool professional. Details regarding the Configuration menu can be found on page 18.

The “Diagnostic Menu” is primarily intended for the service technician and contains information and details about the system operation that are helpful in troubleshooting, if problems occur.

The “Maintenance Menu” will be displayed only if the optional AQL-CHEM is used and the Sensing System is enabled in the Chemistry Config. Wizard. This menu is used to perform functions relating to the AQL-CHEM ORP and pH sensing kit.

Settings Menu

The Settings Menu allows you to set all system operating parameters except the timeclock and countdown timers which are part of the Timers Menu.

⚠ Important: All of the displays shown below use the default generic names for each function or output. The Pro Logic allows more descriptive names to be assigned to each piece of equipment (refer to the section regarding the Configuration Menu for more information).

Spa Heater1
Off

+ - Adjust the desired spa temperature (Off, 65°F, 66°F, ...103°F, 104°F, Off)
 <> Move to previous/next menu item

not shown if Pool and Spa-Dual with separate heaters is selected

Spa Heater2
102°F

+ - Adjust the desired spa temperature (Off, 65°F, 66°F, ...103°F, 104°F, Off)
 <> Move to previous/next menu item

The spa heater setting will only appear if the system has been setup for “spa only” or “pool and spa” operation and the “Heater1” and/or “Heater2” control is enabled. The heater will turn on whenever the pool/spa valves are in the “spa only” position and the filter pump is running and the spa water temperature is less than the desired temperature setting. If you have both solar heat and a conventional heater and the solar priority option is selected (Configuration Menu), then the conventional heater will only operate when solar heat is NOT available.

For Pool and Spa dual equipment with separate heaters (“Pool and Spa -Dual” and “Htr1=Spa, Htr2=Pool” selected), Spa Heater1 is tied to the Spa Filter (AUX1).

Saturation index

The saturation index (Si) relates to the calcium and alkalinity in the water and is an indicator of the pool water "balance". Your water is properly balanced if the Si is 0 ±0.2. If the Si is below -0.2, the water is corrosive and plaster pool walls will be dissolved into the water. If the Si is above +0.2, scaling and staining will occur. Use the chart below to determine the saturation index.

$$Si = pH + Ti + Ci + Ai - 12.1$$

°C	°F	Ti	Calcium Hardness	Ci	Total Alkalinity	Ai
12	53	.3	75	1.5	75	1.9
16	60	.4	100	1.6	100	2.0
19	66	.5	125	1.7	125	2.1
24	76	.6	150	1.8	150	2.2
29	84	.7	200	1.9	200	2.3
34	94	.8	250	2.0	250	2.4
39	103	.9	300	2.1	300	2.5
			400	2.2	400	2.6
			600	2.4	600	2.8
			800	2.5	800	2.9

How to use: Measure pool pH, temperature, calcium hardness, and total alkalinity. Use the chart above to determine Ti, Ci, and Ai from your measurements. Insert values of pH, Ti, Ci and Ai into the above equation. If Si equals .2 or more, scaling and staining may occur. If Si equals -.2 or less corrosion or irritation may occur.

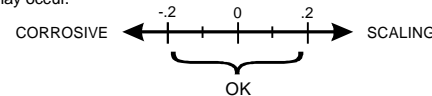

The pool's chemistry must be balanced BEFORE activating the Pro Logic's optional chlorinator function. NOTE: If the pool does not have new water, add metal remover and non-copper based algaecide to the pool, per manufacturer's instructions. This ensures a quick, troublefree transfer to the Pro Logic system.

Salt (When using optional chlorinator function - requires AQL-CL chlorination kit)

Salt Level

Use the chart on the following page to determine how much salt in pounds or (Kgs) should be added to reach the recommended levels. Use the equations below (measurements are in feet/gallons and meters/ liters) if pool size is unknown.

	Gallons (pool size in feet)	Liters (pool size in meters)
Rectangular	Length x Width x Average Depth x 7.5	Length x Width x Average Depth x 1000
Round	Diameter x Diameter x Average Depth x 5.9	Diameter x Diameter x Average Depth x 785
Oval	Length x Width x Average Depth x 6.7	Length x Width x Average Depth x 893

The operating salt level is between 2700-3400 PPM (parts per million) with 3200 PPM being optimal. Before adding any salt, test the salt level. This is especially important for retrofit installation to older pools where chlorine added to the pool over time has ended up as salt. If the level is low, determine the number of gallons in the pool and add salt according to the chart below. A low salt level will reduce the efficiency of the sanitization and result in low chlorine production. A high salt level can cause the Pro Logic to stop

Spa Chlorinator
3%

- + - Adjust the desired chlorinator output for spa (0,1,2,3...9,10,15,20...95,100%)
- <> Move to previous/next menu item

This setting will appear only if the chlorinator function is enabled and system has been setup for "spa only" or "pool and spa-std". If an AQL-CHEM is being used, super chlorinate will not be available if chemical sensing is enabled and ORP is in Auto Sensing (see AQL-CHEM manual). It will determine the chlorinator output when the system is operating in spa-only mode. The actual amount of chlorine introduced into the spa is determined by: this setting, the amount of time the pool operates in spa-only mode, the water temperature, and the amount of salt in the water. If the filter pump is running due to the freeze protection feature, then the chlorinator will not operate during this time.

Pool Chlorinator
60%

- + - Adjust the desired chlorinator output for pool (0,1,2,3...9,10,15,20...95,100%)
- <> Move to previous/next menu item

This setting will appear only if the chlorinator function is enabled and system has been setup for "pool only" or "pool and spa". If an AQL-CHEM is being used, super chlorinate will not be available if chemical sensing is enabled and ORP is in Auto Sensing (see AQL-CHEM manual). It will determine the chlorinator output when the system is operating in pool-only or spa spillover modes. The actual amount of chlorine introduced into the pool is determined by: this setting, the amount of time the filter pump is running, the water temperature, and the amount of salt in the water. If the filter pump is running due to the freeze protection feature, then the chlorinator will not operate during this time.

Spa High Speed
100%

- + - Adjust the desired high speed for variable speed operation
- <> Move to previous/next menu item

This setting will appear if "pool only" is not selected and variable speed filter pump is enabled. This setting determines the speed of the pump during high speed spa operation. This value can be set from 20% to "Highest Speed" in 5% increments. "Highest Speed" is default.

For PS models using dual equipment, this is the spa filter high speed.

Spa Low Speed
50%

- + - Adjust the desired low speed for variable speed operation
- <> Move to previous/next menu item

This setting will appear if "pool only" is not selected and variable speed filter pump is enabled. This setting determines the speed of the pump during low speed spa operation. This value can be set from "Lowest Speed" to 50% in 5% increments. 50% is default.

For PS models using dual equipment, this is the spa filter low speed.

Pool High Speed
100%

- + - Adjust the desired high speed for variable speed operation
- <> Move to previous/next menu item

This setting will appear if "spa only" is not selected and variable speed filter pump is enabled. This setting determines the speed of the pump during high speed pool or spillover operation. This value can be set from 20% to "Highest Speed" in 5% increments. "Highest Speed" is default.

For PS models using dual equipment, this is the pool filter high speed.

Pool Low Speed
50%

- + - Adjust the desired low speed for variable speed operation
- <> Move to previous/next menu item

This setting will appear if "spa only" is not selected and variable speed filter pump is enabled. This setting determines the speed of the pump during low speed pool or spillover operation. This value can be set from "Lowest Speed" to 50% in 5% increments. 50% is default.

For PS models using dual equipment, this is the pool filter low speed.

- Set Day and Time
Wednesday 10:37P

+- Adjust the current day of the week
<> Move to hours setting
- Set Day and Time
Wednesday 10:37P

+- Adjust the current hour (including AM/PM if applicable)
<> Move to minutes setting
- Set Day and Time
Wednesday 10:37P

+- Adjust the current minute
<> Move to previous/next menu item

Use this function to set the current day of the week and time. These values are used for all the automatic timeclock functions of the Pro Logic and are also displayed as part of the default menu.

The Pro Logic is designed to keep the clock running during power outages lasting less than 7 days. If power has been off for longer than 7 days, then the time may have to be reset.

- Display Light
On for 60 sec

+- Toggle between Always On and On for 60 sec.
<> Move to previous/next menu item

This function controls the backlight on the display. If the “On for 60 seconds” option is selected, then the backlight will automatically turn off 60 seconds after the last key is pressed and will stay off until next time a key is pressed.

Note that the Display Light selection only applies to the display keypad that you are currently using. Other display/keypads will not be affected. You need to individually set this option for each display/keypad in the system.

- Beeper
Enabled

+- Toggle between Enabled (default) and Disabled Beeper
<> Move to next menu item

When “Enabled”, the keypad will beep every time a key is pressed. If this audible indication is not desired, select “Disabled”.

This function only applies to the display/keypad that you are currently using. You need to set this option for each display/keypad in your system.

NOTE: This function is not supported on all display/keypads. If the “Enabled” selection is not blinking, then the current software revision of that particular keypad/display does not support the option and it will default to Beeper Enabled.

- Teach Wireless
+ to start

+ Push to start process
<> Move to previous/next menu item
- Press and hold
wireless button

Press any button on wireless remote
<> Move to previous/next menu item
- Teach Wireless
Successful

<> Move to previous/next menu item
- Teach Wireless
NOT Successful

<> Move to previous/next menu item
- Teach Wireless
Base NOT Found

<> Move to previous/next menu item

This menu will only appear if a wireless base station is connected to the Pro Logic. Perform this procedure each time a wireless remote control is added to the Pro Logic system. During this procedure the wireless remote “learns” and remembers the ID code for the wireless base station connected to this particular Pro Logic unit and will reject messages with any other ID codes. If “Base NOT found” is displayed, then the Pro Logic can not communicate with the

Enter/Exit Service (or Service—Timed) Mode

1. Go to Pro Logic main unit (normally mounted near the pool equipment)
2. Pressing the “Service” button rotates through normal operation (red LED off), service mode (red LED on continuously) and service-timed mode (red LED flashing).

Note: This operation can only be performed at the main Pro Logic unit. Both “Service” and “Service-Timed” disable all automatic programmed operations and allow manual operation from the main unit only. The buttons on the remote display/keypads will still be able to turn equipment off in case of an emergency, but will not turn any equipment on. If the system is in “Serviced-Timed” it will automatically switch back to normal operation at the end of the time period.

Chlorinator Operation / Water Chemistry

General Water Chemistry

Salt is required only if you are using the chlorinator features on the Pro Logic Control. If you are NOT using the chlorinator, it is recommended that you follow all of the other chemistry recommendations besides salt. Refer to the description of the Pro Logic configuration menu for information on enabling/disabling the chlorinator (see page 18).

Water Chemistry

The table below summarizes the levels that are recommended by the Association of Pool and Spa Professionals (APSP). The only special requirements for the Pro Logic are the salt level and stabilizer.

CHEMICAL	IDEAL LEVELS
Salt	2700 to 3400 ppm
Free Chlorine	1.0 to 3.0 ppm
pH	7.2 to 7.6
Cyanuric Acid (Stabilizer)	60 to 80 ppm (80 ppm best)
Total Alkalinity	80 to 120 ppm
Calcium Hardness	200 to 400 ppm
Metals	0 ppm
Saturation Index	-0.2 to +0.2 (0.0 best)

Note: Separate chlorinator output levels for the pool and spa must be set. If the valves are in the pool-only or spa spillover positions, then the chlorinator will operate per the pool setting. If the valves are in the spa-only position then the chlorinator will operate according to the spa setting. The actual amount of chlorine introduced into the pool/spa is determined by: this output setting, the amount of time the filter pump is running, the water temperature, and the amount of salt in the water. Also see Start/Stop Superchlorination below.

Start/Stop Superchlorination

1. Press the “MENU” button repeatedly until “Settings Menu” is displayed
2. Press the “>” button repeatedly until “Super Chlorinate” is displayed.
3. The display will show whether superchlorination is “on” or “off”.
4. Press “+” or “-” to toggle between “on” and “off”

Note: Once started, superchlorination will run for the programmed number of hours (Timers Menu/Super Chlorinate Hours) or until you manually turn it off. Superchlorination may be temporarily interrupted for a programmed spa operation.

Program a Timeclock

1. Press the “MENU” button repeatedly until “Timers Menu” is displayed
2. Press the “>” button repeatedly until the “xxx—all days” or “xxx—weekends” is displayed.
3. Use the “+” and “-“ buttons to set the desired start time, then press “>” to switch to the off time. Use the “+” and “-“ buttons to adjust the off time. If you are setting the “weekend” timeclock, press “>” to go to the “weekday” settings.

Note: During the programmed time, there may be other automatic or manual operations that prevent the relay/valve from operating—see a more detailed discussion under Automatic System Operation/Timers Menu/Aux Timeclock or in Troubleshooting/Diagnostic Information.

Program a Countdown Timer

1. Press the “MENU” button repeatedly until “Timers Menu” is displayed
2. Press the “>” button repeatedly until the “xxx—CountDn” is displayed.
3. Use the “+” and “-“ buttons to set the desired timer period.

Note: A setting of 0:00 will display as “Manual On/Off.” The countdown automatic turn off function is disabled by manual operation is still permitted. There may be other automatic or manual operations that prevent the relay/valve from operating—see a more detailed discussion under Automatic System Operation/Timers Menu/Aux Timeclock or in Troubleshooting/Diagnostic Information.

transmitter/receiver base station attached to the main unit. If “NOT Successful” is displayed, then the base station did not receive a signal from the remote control. This may be due to the distance between the Base Receiver and the remote device being too great or may be due to interference caused by other RF equipment operating in the neighborhood. Try using the “Change Channel” command and then repeat the “Teach Wireless” command.

Wireless Channel: 1	+ - Change the desired wireless channel (1 - 5)
	< > If channel is changed, move to confirmation menu If channel is not changed, move to previous/next menu item
Confirm Change: + to proceed	+ Push to confirm the channel change
	< > Move to previous/next menu item
Reteach all wireless units	< > Move to previous (Teach Wireless) menu

This setting changes the channel to be used by the wireless base station and remote(s). If the channel is changed and confirmed, all wireless remote will have to be re-taught. This menu will only appear if a wireless base station is connected to the Pro Logic.

Timers Menu

The Timers Menu allows you to set all timeclock and countdown timers which control the automatic operation of your pool/spa system.

Each timeclock has a single on/off program per day. All of the timeclocks are setup (Configuration Menu) either as “all days” or “weekends/weekdays”. If “weekends/weekdays” are selected, you will need to program on times for both weekdays and weekends and off times for both weekdays and weekends, even if you want them to be the same. All times are adjusted in 15 minute increments (9:00A, 9:15A, 9:30A, etc.). If you program the on time equal to the off time (“10:00A to 10:00A”) the output will NEVER turn on. If you want to disable a timeclock, you can set the on time equal to the off time and you will notice the times disappear and the display simply shows “Off”. If, at a later time, you wish to re-activate the timeclock, simply press either the “+” or “-“ buttons to go back to a normal timeclock programming display.

The Countdown timer is programmed in increments of 5 minutes from “Manual On/Off” (0 minutes) to a maximum of “21:00” (21 hours). When “Manual On/Off” is displayed, the countdown timer is disabled and the output will be manually controlled. When a countdown timer is equal or greater than “0:05”, pressing the appropriate output button will turn the output on and start the timer. Pressing the button again will turn the output off or, when the programmed time has elapsed, the output will automatically turn off.

! Important: All of the displays shown below use the default generic names for each function or output. The Pro Logic allows more descriptive names to be assigned to each piece of equipment (refer to the section regarding the Configuration Menu for more information).

or	Filter T1-all 8:30A to 4:00P	+ - Adjust time setting
		< > Move between start and stop times & to previous/next menu item
	Filter T1-wkend 8:30A to 4:00P	+ - Adjust time setting
		< > Move between start and stop times & to previous/next menu item
	Filter T1-wkday 8:30A to 4:00P	+ - Adjust time setting
		< > Move between start and stop times & to previous/next menu item

For one speed pumps, this is the first filter timeclock and will determine the normal hours of filtration for the pool. For pool/spa combination systems with spillover enabled and filter operation set to “spillover”, the valves will automatically switch to spillover mode at the start of the filtration period. For pool/spa combination systems with spillover enabled and filter operation set to “pool only”, the valves will switch to the pool-only position. Refer to page 11 for general notes regarding timeclock programming.

Quick “How To” Guide

For two speed or variable speed pumps, this setting will be the period of time when the pump runs at high speed (the word “Filter T1” in the display will be replaced with “Filter Hi”). There is a separate timeclock for the low speed operation (see below). If the high speed and low speed periods overlap, then the pump will operate in low speed during the overlap period.

There are several reasons the filter pump may be running at times other than the timeclock period set above. These include super-chlorination, spa operation, manual operation, heater cooldown, freeze protection, heater-extend and solar-extend.

or	Filter T2-all 8:30A to 4:00P	+ - Adjust time setting	< > Move between start and stop times & to previous/next menu item
	Filter T2-wkend 8:30A to 4:00P	+ - Adjust time setting	< > Move between start and stop times & to previous/next menu item
	Filter T2-wkday 8:30A to 4:00P	+ - Adjust time setting	< > Move between start and stop times & to previous/next menu item

For one speed pumps, this is the second filter timeclock.

For two speed or variable speed pumps, this timeclock will set the normal time period for **filter pump low speed operation** (the word “Filter T2” in the display will be replaced with “Filter Lo”). If the filter pump is off for more than 30 seconds, the pump will first turn on at high speed for 3 minutes to prime and establish water flow. Afterwards, it will drop down to low speed for the remainder of the programmed low speed time period. While this time clock will override the high speed timeclock (see above), there are several reasons why the pump will automatically switch to high speed operation during this programmed time period. These include manual operation, spa operation, or heating operation.

or	Spa-all 6:00P to 9:00P	+ - Adjust time setting	< > Move between start and stop times & to previous/next menu item
	Spa-wkend 6:00P to 9:00P	+ - Adjust time setting	< > Move between start and stop times & to previous/next menu item
	Spa-wkday 6:00P to 9:00P	+ - Adjust time setting	< > Move between start and stop times & to previous/next menu item

This menu is only available if the system has been setup for “spa only” or “pool and spa-std”. During the programmed spa time, the Pro Logic will move the pool/spa valves into the “spa-only” position and turn on the filter pump. The heater will automatically heat the spa up to the programmed spa temperature. This programmed spa operation will take precedence over all other automatic functions, only manual operation of the filter button or pool/spa valve button will override this function.

If your pool has a separate jet pump or blower controlled by Aux1 and/or Aux2, you will have to program those separately.

Operate the Spa—Manually

1. Press the “Pool/Spa” button to go to “spa-only” operation (“SPA” LED illuminated). In some cases, this may take more than one press of the button.
2. If the filter pump is not already on, press the “FILTER” button to turn it on.
3. If the spa is below the desired temperature, the heater will turn on automatically when the filter pump is on and the valves are in the spa-only position. If you have not already set the desired temperature for the spa, see “Set Heater Temperature” below
4. If the spa has a separate jet pump and or blower, determine if the jet pump/blower is controlled by any Aux or the Lights relay (it should be marked on the label inside the door). Then press the appropriate button to turn on the jets/blower.

Operate the Spa—Automatically

1. Press the “MENU” button repeatedly until “Timers Menu” is displayed
2. Press the “>” button repeatedly until the “Spa—all days” or “Spa—weekends” is displayed.
3. Use the “+” and “-“ buttons to set the desired start time, then press “>” to switch to the off time. Use the “+” and “-“ buttons to adjust the off time. If you are setting the “weekend” timeclock, press “>” to go to the “weekday” settings.

Note: During the programmed spa time, the valves will automatically switch to the “spa-only” position, the filter pump will turn on, and, if the spa is not up to the desired temperature, the heater will start. This operation is the highest priority and will take precedence over other automatically programmed operations. At the end of the spa period, the Pro Logic will return to its normally programmed operation state.

Set the Heater Temperature (or turn heater permanently off)

1. Press the “MENU” button repeatedly until “Settings Menu” is displayed
2. Press the “>” button repeatedly until the “Spa Heater” or “Pool Heater” is displayed.
3. Press the “+” or “-“ buttons repeatedly to adjust the temperature. If you adjust the temperature below 65°F or above 104°F the display will indicate “off” and the heater will not operate regardless of temperature.

Note: Separate temperatures for the pool and spa must be set. If the valves are in the pool-only or spa spillover positions, then the heater will use the pool setting. If the valves are in the spa-only position then the heater will operate according to the spa setting.

Set the Chlorinator Output

1. Press the “MENU” button repeatedly until “Settings Menu” is displayed.
2. Press the “>” button repeatedly until the “Spa Chlorinator” or “Pool Chlorinator” is displayed.
3. Press the “+” or “-“ buttons repeatedly to adjust the setting. If you adjust the setting to 0% the chlorinator will be off all the time.

- Time Format
12 hour AM/PM + - Toggle between 12 hour AM/PM (default) and 24 hour time format options
 <> Move to previous/next configuration menu
- Units
°F and PPM + - Toggle between °F and PPM (default) and °C and g/L (Metric) options
 <> Move to previous/next configuration menu

- Reset Config. to
Default Press + + Initiate reset of all configuration parameters
 <> Move to previous/next configuration menu (config. not reset)

- Are you sure?
+ to proceed + Reset all configuration parameters
 <> Move to previous/next menu (config. not reset)

- Config. reset
Confirmed <> Move to previous/next configuration menu

Use this function to erase all previous system configuration settings and reset all configuration parameters back to the factory default values. This function is NOT reversible--be careful.

Maintenance Menu (only displays if Sensing System is enabled)

The Maintenance Menu will be displayed only if the optional AQL-CHEM is used and the Sensing System is enabled in the Chemistry Config. Wizard. This menu is used to perform functions relating to the AQL-CHEM ORP and pH sensing kit.

- pH Calibration
Wizard, + to enter + Push to access pH Calibration Wizard
 <> Move to previous/next menu item

Use this Wizard to calibrate the AQL-CHEM's pH probe. This requires a manual pH test of the pool water using a dependable red phenol test kit.

- Clean Probe Wizard
+ to enter + Push to access Clean Probe Wizard
 <> Move to previous/next menu item

Use this Wizard to clean the AQL-CHEM's ORP and pH probes. The probes must be clean and free from oil, chemical deposits and contamination to function properly. Slow response, increased need to calibrate, and inconsistent readings are indications that the probes need to be cleaned.

- Lights-all
8:00P to 11:00P + - Adjust time setting
 <> Move between start and stop times & to previous/next menu item
 - or
 - Lights-wkend
8:00P to 11:00P + - Adjust time setting
 <> Move between start and stop times & to previous/next menu item
 - Lights-wkday
8:00P to 11:00P + - Adjust time setting
 <> Move between start and stop times & to previous/next menu item
- This menu will appear only if the Lights are configured for timeclock. The lights will turn on and off at the designated times. The only override on this function is manual on/off control by the "Lights" button.
- or
 - Lights-CountDn
0:20 + - Adjust time setting (Manual On/Off, 0:05, 0:10, 0:015...)
 <> Move to previous/next menu item
- This menu will appear only if the Lights are configured for countdown timer. This setting is the time after you manually turn on the lights until the Pro Logic automatically turns off the lights. You can also manually turn off the lights at an earlier time by pressing the LIGHTS button.

- Spa Filter T1-all
8:30A to 4:00P + - Adjust time setting
 <> Move between start and stop times & to previous/next menu item
- or
- Spa Filter T1-wkend
8:30A to 4:00P + - Adjust time setting
 <> Move between start and stop times & to previous/next menu item
- Spa Filter T1-wkday
8:30A to 4:00P + - Adjust time setting
 <> Move between start and stop times & to previous/next menu item

This menu is only available if the system has been setup for Dual Equipment. For one speed pumps, this is the first spa filter timeclock and will determine the normal hours of filtration for the spa. For pool/spa combination systems with spillover enabled, the valves will automatically switch to pool only at the start of the filtration period.

For two speed or variable speed pumps, this setting will be the period of time when the spa pump runs at high speed (the word "Spa Filter T1" in the display will be replaced with "Spa Filter Hi"). There is a separate timeclock for the low speed operation (see below). If the high speed and low speed periods overlap, then the pump will operate in low speed during the overlap period.

There are several reasons the spa filter pump may be running at times other than the timeclock period set above. These include spa operation, manual operation, heater cooldown and freeze protection.

- Spa Filter T2-all 8:30A to 4:00P +-- Adjust time setting
<> Move between start and stop times & to previous/next menu item
- or
- Spa Filter T2-wkend 8:30A to 4:00P +-- Adjust time setting
<> Move between start and stop times & to previous/next menu item
- Spa Filter T2-wkday 8:30A to 4:00P +-- Adjust time setting
<> Move between start and stop times & to previous/next menu item

For one speed spa pumps, this is the second filter timeclock

For two speed or variable speed pumps, this timeclock will set the normal time period for **spa filter pump low speed operation** (the word “Spa Filter T2” in the display will be replaced with “Spa Filter Lo”). If the filter pump is off for more than 30 seconds, the pump will first turn on at high speed for 3 minutes to prime and establish water flow. Afterwards, it will drop down to low speed for the remainder of the programmed low speed time period. While this time clock will override the high speed timeclock (see above), there are several reasons why the pump will automatically switch to high speed operation during this programmed time period. These include manual operation, spa operation, or heating operation.

For PS-4, Aux1 and Aux2 configurations are identical. For PS-8 models, Aux1 - Aux6 configurations are identical. For PS-16 models, Aux1 - Aux14 configurations are identical.

- Aux1-all 8:30A to 4:00P +-- Adjust time setting
<> Move between start and stop times & to previous/next menu item
- or
- Aux1-wkend 8:30A to 4:00P +-- Adjust time setting
<> Move between start and stop times & to previous/next menu item
- Aux1-wkday 8:30A to 4:00P +-- Adjust time setting
<> Move between start and stop times & to previous/next menu item

This menu will appear only if the Aux1 is configured for timeclock. The Aux1 output will turn on and off at the designated times. If the Aux1 relay is off during the programmed on time—note that some pool equipment (example pressure side pool cleaner) can only be operated when the filter pump is running and the pool/spa valves are in the pool-only position—the Pro Logic will keep the relay off until these other conditions are suitable for operation. If the Aux1 relay is on during the programmed off time, it may be because of freeze protection. Also, manual operation overrides the timeclock. Refer to page 11 for general notes regarding timeclock programming.

- Aux1-CountDn 0:20 +-- Adjust time setting (Manual On/Off, 0:05, 0:10, 0:15...)
<> Move to previous/next menu item

This menu will appear only if the Aux1 is configured for countdown timer. This setting is the time after you manually turn on the Aux1 relay until the Pro Logic automatically turns off the relay. You can also manually turn off the relay at an earlier time by pressing the AUX1 button.

if AQL-SS-D is connected

- Digital Spa Config. + to view/change + Push to access the Digital Spa Side Remote options
<> Move to previous/next configuration menu
- Select Digital Spa A +-- Rotates between all available remotes
<> Move to next menu item
- Digital A, Button 1 Pool/Spa +-- Rotates between System Off, Pool/Spa, Filter, Lights, Heater1, Valve3, Valve4, and all available Aux outputs
<> Move to previous/next menu item
- Digital A, Setpoint Heater1 +-- Rotates between heaters that are enabled
<> Move to previous menu item or next configuration menu

Select Digital Spa

This menu only appears if more than one AQL-SS-D is detected at power up. Select which of the available remote controls (A, B or C) is to be configured.

Digital A, Button 1

This menu allows the user to map each button of the AQL-SS-D to one of the standard Pro Logic functions. The default selections are: Button 1 - Pool/Spa, Button 2 - Filter, Button 3 - Lights, Button 4 - Heater1, Button 5 - Valve3, Button 6 - Valve4, Button 7 - Aux 1 and Button 8 - Aux2.

Digital A, Setpoint

If more than one heater is installed, select the spa heater you wish to control. If no heaters are installed, “Heaters Disabled” will be displayed.

- Remote Menu Enabled +-- Toggle between Enabled (default) and Disabled Remote Menu
<> Move to previous/next configuration menu

This feature will prevent unauthorized access to the Settings, Timers, and Configuration menus from any of the Pro Logic’s remote display/keypads. When disabled, the remote display/keypads will only show the default menu and allow on/off control via the pushbuttons. Note that the function of the Pro Logic’s built-in display/keypad is unchanged by this selection. Once disabled, the only way to enable “Remote Menus” is to use the local display/keypad.

- All Timeclocks 7-day +-- Toggle between 7-day (default) and Weekend/Weekday time options
<> Move to previous/next configuration menu

This selection affects ALL of the timeclock logic in the Pro Logic. If “7-day” is selected, each timeclock will have one set of turn-on/turn-off settings that operate every day of the week. If “Weekend/Weekdays” option is selected then the user can enter one set of turn-on/turn-off times for the weekend (fixed as Saturday/Sunday) and another set of turn-on/turn-off times for weekdays (Monday through Friday).

A table of functions and their corresponding control parameters are listed below.

Function	Control Parameter
Pool/Spa	Unaffected, Pool only, Spa only, or Spillover
Pool Filter	Unaffected, Off, On, High speed, or Low speed
Lights (standard relay)	Unaffected, Off, or On
Lights (dimmer relay)	Unaffected, Off, On, 100%, 80%, 60%, 40%, or 20%
Spa Filter	Unaffected, Off, On, High speed, or Low speed
Aux1-14 (standard relay)	Unaffected, Off, or On
Aux1-14 (dimmer relay)	Unaffected, Off, On, 100%, 80%, 60%, 40%, or 20%
Valve3	Unaffected, Off, or On
Valve4	Unaffected, Off, or On
Spa Htr1 Set	Unaffected, Off, 65°-104°F
Pool Htr1 Set	Unaffected, Off, 65°-104°F
Spa Htr2 Set	Unaffected, Off, 65°-104°F
Pool Htr2 Set	Unaffected, Off, 65°-104°F
Spa Solar Set	Unaffected, Off, 65°-104°F
Pool Solar Set	Unaffected, Off, 65°-104°F
SuperChlr	Unaffected, Off, On
Spa High	Unaffected, 20% to Highest speed
Spa Low	Unaffected, Lowest speed to 50%
Pool High	Unaffected, 20% to Highest speed
Pool Low	Unaffected, Lowest speed to 50%

Note that all functions in the table may not be offered. The available functions are dependent on how the Pro Logic is configured. For example, if the Pro Logic is configured for a single heater, “Heater2” will not be available as an option in the Group menu. Also, under some circumstances, functions will be displayed but can’t be changed. Note that the function whose menu you are in, will not be displayed as an option and will automatically turn on when the group is activated. For example, if programming a Group function under the Lights menu, the Lights function will not be offered as an option and the Lights function will automatically turn on with the group.

The available control parameters vary with each function. All functions offer “Unaffected”, which should be selected if you do not wish to control that particular function within the group. All other parameters will depend on the particular function selected.

When activating Group functions, be aware that the most recent Group function that you activate will override any previous Group functions.

Heater Setpoints in Groups

The Pro Logic can be programmed to use alternate heater setpoints (conventional and/or solar) while running group commands. This allows the heater to be set to a higher or lower temperature than normal, while the group is activated. When the group stops, the setpoint will return to its normal setting.

Changing the setpoint while the Group is running will make the Group release the alternate setpoint control and revert back to the normal heater setting. Any changes that are made at that point will affect the normal heater setting. The next time the Group is activated, the temperature will return to the group setpoint that was originally programmed in the Configuration Menu. To change the setpoint while the Group is running, go to the Settings menu and press the +/- button while “Group Control” is displayed. The setpoint will change and be retained as the new normal heater setpoint.

NOTE: The configuration for Valve3 and Valve4 are identical. However, if Heater2 was enabled, then the Valve4 configuration will not appear (a single relay is used to implement either the Heater2 function or the Valve4 function-it can not do both). For PS-16, see aux logic on page 27 for control of Valves7, 8, 9 and 10.

- Valve3 Config. + Push to access Valve3 options
+ to view/change <> Move to previous/next configuration menu
- Valve3 Name Waterfall +- Rotates between all available names
<> Move to next menu item
- Valve3 Function Solar +- Rotates between Manual On/Off (default), Countdown Timer, Timeclock, Solar, In-floor Cleaner, Group, and Super Chlorinate
<> Move to next menu item
- for all functions except solar, group or super chlorinate*
Valve3 Interlock Disabled +- Toggle between Enabled and Disabled (default) Valve3 Interlock
<> Move to next menu item
- for group function only*
Valve3 Group Timer: None(Manual) +- Rotates between Manual On/Off (default), Countdown Timer and Timeclock
<> Move to next menu item
- for group function only*
Valve3 Group Filter: Unaffected +- Options available depend on the function that is selected
<> Move to previous/next menu item or next configuration menu
- for all functions except group and super chlorinate*
Valve3 Freeze Disabled +- Toggle between Enabled and Disabled (default) Valve3 Freeze
<> Move to previous/next configuration menu

Valve3 Name

The Pro Logic allows you to assign any one of a number of names (e.g. “Cleaner Valve, Waterfall valve, Solar Valve, etc.) to each of the valve output control function. This will make the Pro Logic much more user friendly to the homeowner when they want to turn various valves on or off or program the timeclocks. A sheet of small name labels is included with the Pro Logic main unit and each remote display/keypad so that the “Valve3” (and “Valve4”) pushbutton can be labeled the same as the name that you have assigned.

Valve3 Function

Manual On/Off (default) – the valve3 relay will alternate between turning on and off when the VALVE3 button is pressed. There is no automatic control logic. The VALVE3 button can also be used to turn the valve output on or off.

Countdown Timer – the valve3 relay will turn on when the VALVE3 button is pressed and then will turn off automatically after a programmed time (see Timers Menu in the Operations Manual). The VALVE3 button can also be used to turn the output off.

Timeclock – the valve turns on/off at the times set for the valve3 timeclock in the Timers Menu (see Operations Manual). The valve3 button can also be used to turn the valve output on or off.

Solar – the valve operates when the filter pump is running and solar heat is available and the water is less than the desired temperature setting. Solar heating must be enabled in the “Solar Config. menu for proper operation to occur.

In-Floor Cleaner – the valve switches the water returning to the pool between the in-floor cleaner and the normal return jets which facilitate efficient surface skimming. The valve will operate the in-floor cleaner for the first half of each clock hour and then switch to the jets/skimming for the last half of the hour.

Group – the valve operates when the Group function is initiated and shuts off when the Group function is terminated. See valve3 Group section for operation information for the Group function.

Cell Type Selection

The Cell Type Menu appears after “Display Salt/Minerals” in the Chlorinator Configuration Menu. The options are T-CELL-5 or T-CELL-15 (default). Make the proper selection based on the electrolytic cell that is used in your system. For pools up to 20,000 gallons, the T-CELL-5 is typically used. The T-CELL-15 is for pools up to 40,000 gallons.

Chemistry Config.
Wizard + to enter

- + Push to access Chemistry Config. Wizard
- <> Move to previous/next menu item

Chemistry Configuration Wizard

Requires use of the optional AQL-CHEM Sensing Kit. Following the steps of the Chemistry Config. Wizard will set up the AQL-CHEM to sense ORP and pH levels and, if the AQL-CL chlorination kit is used, can configure the Pro Logic to generate the correct amount of chlorine to properly sanitize the pool. Refer to the AQL-CHEM manual for more detailed information.

Pool/Spa Config.
+ to view/change

- + Push to access Pool/Spa options
- <> Move to previous/next configuration menu

Pool/Spa Setup
Pool and Spa-Std

- + Rotates between Pool and Spa-Std (default), Pool and Spa-Dual, Pool Only, and Spa Only options
- <> Move to next menu item

if “Pool and Spa-Dual” is selected

Heaters
Htr1 = Spa, Htr2 = Pool

- + Toggle between Htr1=Spa, Htr2=Pool (default) and Shared Heaters
- <> Move to next menu item

if “Pool and Spa-Std” is selected

Spa - CountDn
00:30

- + Adjust time setting (Manual On/Off, 0:05, 0:10, 0:15..., (default is 4:00))
- <> Move to next menu item

if “Pool and Spa-Std or Dual” is selected

Spa Spillover
Enabled

- + Toggle between Enabled and Disabled (default) Spa Spillover
- <> Move to next menu item or previous/next configuration menu

if “Pool and Spa-Std or Dual” is selected and if “Spa Spillover” is enabled

Filter Operation
Spa Spillover

- + Toggle between Pool Only (default) and Spa Spillover options
- <> Move to previous/next configuration menu

if “Pool Only” or “Spa Only” is selected

V1=Aux1, V2=Aux2
Disabled

- + Toggle between Enabled and Disabled (default)
- <> Move to previous/next configuration menu

if “Pool and Spa-Std” is selected

Filter Off Valve
Change: Enabled

- + Toggle between Enabled (default) and Disabled
- <> Move to previous/next configuration menu

Pool/Spa Setup

If “Pool Only” or “Spa Only” are selected, then the pool/spa valves are not needed and pushing the POOL/SPA button on the display/keypad will have no effect. If “Pool and Spa-Std” is selected, then the pool/spa suction and return valve actuators should be connected to the Pro Logic. Pressing the POOL/SPA button on the display/keypad will allow the homeowner to alternate between pool and spa operation. If “Pool and Spa-Dual” is selected, then only the Pool/Spa return valve actuator should be connected to the Pro Logic.

NOTE: If “Pool and Spa-Dual” is selected, Aux1 is dedicated to use as the spa filter. Its Name is set to Spa Filter, the Function is set to Timeclock and Interlock is set to Disabled. These can't be changed.

Aux1 Name

The Pro Logic allows you to assign any one of a number of names (e.g. “Cleaner Pump, Waterfall, Gazebo Light, etc.) to each of the aux outputs control function. This will make the Pro Logic much more user friendly to the homeowner when they want to turn various aux equipment on or off or program the timeclocks. A sheet of small name labels is included with the Pro Logic main unit and each remote display/keypad so that the “Aux” pushbutton can be labeled the same as the name that you have assigned. At this time it is also a good idea to make sure that the relay in the control box is also labeled (hand written) with the same name as a help to technicians who may service this system at a later date.

Aux1 Function

Manual On/Off (default)—the aux relay will alternate between turning on and off when the aux button is pressed. There is no automatic control logic.

Countdown Timer – the aux relay will turn on when the AUX button is pressed and then will turn off automatically after a programmed time (see Timers Menu in the Operations Manual). The AUX button can also be used to turn the output off.

Low Speed of a 2-speed Filter Pump – the Pro Logic will operate the aux relay whenever the low speed operation of the filter pump is required. It is very important that the “2-speed” filter pump option be selected under the “Filter Config.” Menu for proper operation.

Timeclock – the aux relay will turn-on and turn-off at the times set for the aux timeclock in the Timers Menu (see Operations Manual). The AUX button can also be used to turn the output on and off.

Solar – the aux relay operates a solar booster pump which will turn on when the filter pump is running and solar heat is available and the water is less than the desired temperature setting. It is important to note that “Solar” must be enabled in the “Solar Config.” menu for proper operation to occur.

Low Speed of a 2-Speed Spa Filter Pump – the Pro Logic will turn on the aux relay whenever the low speed operation of the Dual Equipment Spa filter pump is required. “Pool and Spa-Dual” (located in Pool/Spa Setup menu) and “2-Speed” (located in Spa Filter Config. menu) must be selected for proper operation.

Group – the aux relay operates when the Group function is initiated and shuts off when the Group function is terminated. See Aux1 Group section for operation information for the Group function.

Super Chlorinate – The Super Chlorinate function can be assigned to any Aux, Lights or Valve button. This allows the user to simply hit a button to start a Super Chlorinate cycle, rather than using the Settings Menu. Note that only one button can be assigned to this function.

pH Dispense – When Chemistry Sensing is enabled and pH Reduction Control is NOT disabled, the Pro Logic will turn on the Aux relay when there is a need to energize the pH dispensing device. The pH Dispense function can be assigned to any Aux or the Lights output. Once programmed for pH Dispense, the Aux button will have no function. Requires the use of the AQL-CHEM sensing kit.

Aux1 Relay

This feature allows the user to select either “Standard” (default) or “Dimmer” type relay for the Aux1 output. The optional AQL-DIM dimmer kit must be installed if “Dimmer” is desired. When “Dimmer” is selected, and the Aux1 output is manually turned on, the “+” and “-” buttons adjust the level from 20% to 100% (default). The level is saved for the next time the aux1 output is turned from off to on.

Lights Interlock

If enabled, this feature will override the function (Manual On/Off, Countdown Timer, Timeclock) selected above and turn the lights relay off when: filter pump is off, first 3 minutes of filter pump operation (allows the pump to prime and get water flowing), when the pool/spa suction return valves are in any position other than “pool only”, or for the first 3 minutes after solar turns on (allows air in the solar panels to be purged). Interlock is not available for solar, low speed filter pump, dimmer, group, super chlorinate or pH dispense functions.

Lights Group

The Lights Group function allows the user to perform multiple tasks with a single push of the “Lights” button. When setting up a Group function, refer to page 16 for specific programming information. There are two Group menus; the first menu determines how the group command will be initiated (Manual On/Off, Countdown Timer, or Timeclock) and the second menu selects the desired functions and their respective control parameters.

When activating Group functions, be aware that the most recent Group function that is initiated will override any previous Group function.

Lights Freeze Protection

This function helps protect equipment that is wired to the lights relay against freeze damage. If Freeze Protection is enabled and the AIR temperature sensor falls below the selected freeze temperature threshold, the Pro Logic will energize the lights relay. **IMPORTANT:** this only enables operation of the lights relay during freeze--see the “Filter Pump Config.” menu to enable freeze protection for the main circulation system. Freeze Protection is not available for low speed filter pump, dimmer, group, super chlorinate or pH dispense functions.

NOTE: The configuration parameters for all Aux outputs are same as shown below for Aux1. PS-4: Aux1 and Aux2. PS-8: Aux1 through Aux6. PS-16: Aux1 through Aux14. Also note that for the PS-16, Valves7, 8, 9 and 10 are turned On/Off with the control function selected for Aux7, 8, 9, and 10, respectively.

Aux1 Config. + to view/change	+ Push to access Aux options <> Move to previous/next configuration menu
Aux1 Name Cleaner	+ Rotates between all available names <> Move to next menu item
Aux1 Function Manual On/Off	+ Rotates between Manual On/Off (default), Countdown Timer, Low Speed- Filter, Timeclock, Solar, Low Speed-Spa Filter, Group, Super Chlorinate, and pH Dispense <> Move to next menu item
<i>for manual on/off, countdown timer and timeclock functions</i>	
Aux1 Relay Standard	+ Toggle between Standard (default) and Dimmer <> Move to next menu item or previous/next configuration menu
<i>for all functions except solar, dimmer relay, super chlorinate low speed, group and pH dispense</i>	
Aux1 Interlock Disable	+ Toggle between Enabled and Disabled (default) Aux1 Interlock <> Move to next menu item
<i>for group function only</i>	
Aux1 Group Timer: None(Manual)	+ Rotates between Manual On/Off (default), Countdown Timer and Timeclock <> Move to next configuration menu item
<i>for group function only</i>	
Aux1 Group Filter: Unaffected	+ Options available depend on the function that is selected <> Move to previous/next menu item or next configuration menu
<i>for all functions except dimmer relay, super chlorinate low speed, group and ph dispense</i>	
Aux1 Freeze Disable	+ Toggle between Enabled (default) and Disabled Aux1 Freeze <> Move to previous/next configuration menu

⚠ WARNING: Do not use the Pro Logic to control an automatic pool cover. Swimmers may become entrapped underneath the cover.

Heaters

This menu will only appear if Pool/Spa setup is set to “Pool and Spa-Dual”. This allows the heater(s) to either be shared between the pool and spa (“Shared” selected) or for Heater1 to be dedicated to the spa and Heater2 to be dedicated to the pool (“Htr1=Spa, Htr2=Pool” selected).

Spa CountDn

This menu will appear only if Pool/Spa Setup is set to “Pool and Spa-Std”. This setting is the time, after you manually switch the Pool/Spa valves to “Spa Only”, until the Pro Logic automatically returns the valves to their previous positions. It is programmed in increments of 5 minutes, from “Manual On/Off” (0 minutes) to “21:00” (21 hours). The filter is forced on during this time period.

Spa Spillover

When spa spillover is “Enabled” and “Pool and Spa-Std”, the homeowner will be able to rotate through “Pool Only” (both suction and return valves switched to pool), “Spa Only” (both suction and return valves switched to spa) and “Spillover” (suction valve switched to pool and return valve switched to spa) by successive presses of the “Pool/Spa” button. For “Pool and Spa-Dual”, only “Pool Only” and “Spillover” are available.

Filter Operation

If “Spa Spillover” is selected, the Pro Logic will automatically switch the pool/spa suction and return valves to “spillover” at the start of the programmed pool filtering time period or when the super-chlorinate function is turned on. The valves will remain in this position for the remainder of the super-chlorinate period. This option is usually preferable because both the pool and spa water will be filtered and sanitized.

If “Pool Only” is selected, then the Pro Logic will switch the pool/spa valves to the “pool only” position at the start of the programmed pool filtering time period or when the super-chlorinate function is turned on. This may be desirable on some systems with in-floor cleaners because it allows the cleaner to operate all the time the pool is being filtered and/or the super chlorinate is running.

V1=Aux1, V2=Aux2

This menu appears only if the Pool/Spa Setup is “Pool Only” or “Spa Only”. When enabled, Valve 1 (return) will follow the Aux1 output and Valve 2 (suction) will follow the Aux2 output. When disabled (default), the return and suction pool/spa valves function normally.

Filter Off Valve Change

This menu appears only if Pool/Spa setup is set to “Pool and Spa”. When enabled (default), the filter pump will shut off for 35 seconds whenever the Pool/Spa valves are turning. The pump will NOT shut off when the heater has Cooldown enabled and is either on or in the Heater Cooldown mode.

Filter Config. + to view/change	+ Push to access pump options <> Move to previous/next configuration menu
Filter Name Pool Filter	+ Rotates between all available names <> Move to next menu item
Filter Pump 1 Speed	+ Rotates between 1-speed (default), 2-speed and variable speed options <> Move to next menu item
<i>if "Variable Speed" is selected</i>	
Lowest Speed 10%	+ Adjust the lowest speed desired for variable speed operation <> Move to next menu item
<i>if "Variable Speed" is selected</i>	
Highest Speed 100%	+ Adjust the highest speed desired for variable speed operation <> Move to next menu item
Flow Monitor Disabled	+ Toggle between Enabled and Disabled (default) Flow Monitor <> Move to next menu item
Freeze Protect Enabled	+ Toggle between Enabled (default) and Disabled Freeze Protection <> Move to next menu item or previous/next configuration menu
<i>if "Freeze Protect" is enabled and "1-speed Filter" is not selected</i>	
Freeze Protect High Speed	+ Toggle between high speed (default) and low speed <> Move to next menu item
<i>if "Freeze Protect" is enabled</i>	
Freeze Temp 38°F	+ Adjust the desired freeze protection temperature (33°F - 42°F) <> Move to previous/next configuration menu

Filter Name

The Pro Logic allows you to assign any one of a number of names (e.g. "Filter Pump, Pool Filter, Spa Filter, etc.) to the filter relay. This will make the Pro Logic more user friendly to the homeowner when they want to control the filter equipment. A sheet of small name labels is included with the Pro Logic main unit and each remote display/keypad so that appropriate pushbuttons can be labeled the same as the name that you have assigned.

Filter Pump

For 2-speed pumps: When a 2-speed pump is configured, one of the AUX relays must also be configured to control the low speed motor winding on the pump. Refer to the appropriate sections in the Installation manual for specific information regarding the control logic for 2-speed and variable speed pump operation.

For the Hayward Tristar variable speed pump: The Filter relay is used to supply input power to the VSC pump control. The relay will be on when the filter pump output is on. When the filter pump output is off, the relay will be off. On, off and speed is controlled by commands sent to the pump.

Lowest Speed

This is the lowest speed that the variable speed pump is allowed to run at. It is used as the lower limit in the Low Speed Settings Menu. Set lowest speed from 10% (default) to 50%.

Highest Speed

This is the highest speed that the variable speed pump is allowed to run at. It is used as the upper limit in the High Speed Settings Menu. Also, this is the speed that the pump will run at during the first 3 minutes of operation anytime the pump has been off for more than 30 seconds. Set highest speed from 20% to 100% (default).

can be labeled the same as the name that you have assigned. At this time it is also a good idea to make sure that the relay in the control box is also labeled (hand written) with the same name as a help to technicians who may service this system at a later date.

Lights Function

Although designated as the "Lights" output, the function of the lights relay is similar to the Aux relays. If pool lights are wired to the lights relay, some options including Solar function, Low Speed of a 2-Speed Filter Pump, Lights Interlock and Lights Freeze Protection are not applicable and should be disabled. If no pool lights are used, the lights relay can be used to control other pool devices that may require these options. The function of each option is shown below.

Manual On/Off—the lights relay will alternate between turning on and off when the LIGHTS button is pressed. There is no automatic control logic.

Countdown Timer—the lights relay will turn on when the LIGHTS button is pressed. The lights relay will turn off automatically after a programmed time (see Timers Menu in Operation Manual). The LIGHTS button can also be used to turn the output off.

Low Speed of a 2-speed Filter Pump – the Pro Logic will turn on the lights relay whenever the low speed operation of the filter pump is required. It is very important that the "2-speed" filter pump option be selected under the "Filter Config." Menu for proper operation.

Timeclock – the lights relay will turn-on and turn-off at the times set for the lights timeclock in the Settings Menu (see Settings Menu in Operation Manual). The LIGHTS button can also be used to turn the output on and off.

Solar – the lights relay can operate a solar booster pump which will turn on when the filter pump is running and solar heat is available and the water is less than the desired temperature setting. It is important to note that "Solar" must be enabled in the "Solar Config." menu for proper operation to occur.

Low Speed of a 2-Speed Spa Filter Pump – the Pro Logic will turn on the lights relay whenever the low speed operation of the Dual Equipment Spa filter pump is required. "Pool and Spa-Dual" (located in Pool/Spa Setup menu) and "2-Speed" (located in Spa Filter Config. menu) must be selected for proper operation.

Group – the lights relay operates when the Group function is initiated and shuts off when the Group function is terminated. See Lights Group section for operation information for the Group function.

Super Chlorinate – The Super Chlorinate function can be assigned to any Aux, Lights or Valve button. This allows the user to simply hit a button to start a Super Chlorinate cycle, rather than using the Settings Menu. Note that only one button can be assigned to this function.

pH Dispense –When Chemistry Sensing is enabled and pH Reduction Control is NOT disabled, the Pro Logic will turn on the Lights relay when there is a need to energize the pH dispensing device. The pH Dispense function can be assigned to any Aux or the Lights output. Once programmed for pH Dispense, the Lights button will have no function. Requires the use of the AQL-CHEM sensing kit.

Lights Relay

This feature allows the user to select either "Standard" (default) or "Dimmer" type relay for the Lights output. The optional AQL-DIM dimmer kit must be installed if "Dimmer" is desired. When "Dimmer" is selected, and the Lights output is manually turned on, the "+" and "-" buttons adjust the level from 20% to 100% (default). The level is saved for the next time the lights are turned from off to on.

If solar is “Enabled”, the valve or solar pump relay will turn on when the water temperature is less than the desired temperature setting AND the solar sensor is hotter than the water by at least 8°F. The desired temperature is in the “Settings Menu”. If applicable, the homeowner will be prompted to enter separate pool and spa desired temperature settings. Depending on the position of the pool/spa suction valve, the proper temperature setting will be used.

Solar Extend

If “Enabled”, the filter extend logic keeps the filter pump running beyond the normal turn-off time if solar heat is still available. When solar heat is no longer available, both the solar valve/pump and filter pump will turn off simultaneously. Solar extend will NOT cause the filter pump to turn on, it will only delay the turn off time when solar is operating.

Solar Priority

If both “Solar Control” and “Heater Control” are enabled, the Solar Priority feature will keep the conventional heater off whenever solar heat is available. This provides the most cost effective way of heating the pool. When solar heat is not available, the conventional heater will operate normally.

Allow Low Speed

This menu only appears if the pool filter is configured for 2-speed or variable speed operation. During default operation, high speed mode is used whenever the solar heater is on. If Allow Low Speed is enabled, low speed pump operation will be allowed during solar heating except for the first 3 minutes after solar heat turns on.

Lights Config. + to view/change	+	Push to access Lights options
	<>	Move to previous/next configuration menu
Lights Name Pool Light	+ -	Rotates between all available names
	<>	Move to next menu item
Lights Function Manual On/Off	+ -	Rotates between Manual On/Off (default), Countdown Timer, Low Speed- Filter, Timeclock, Solar, Low Speed-Spa Filter, Group, Super Chlorinate, and pH Dispense
	<>	Move to next menu item
<i>for manual on/off, countdown timer and timeclock functions</i>		
Lights Relay Standard	+ -	Toggle between Standard (default) and Dimmer
	<>	Move to next menu item or previous/next configuration menu
<i>for all functions except solar, dimmer relay, super chlorinate pH dispense, low speed, and group</i>		
Lights Interlock Disable	+ -	Toggle between Enabled and Disabled (default) Lights Interlock
	<>	Move to next menu item
<i>for group function only</i>		
Lights Group Timer: None(Manual)	+ -	Rotates between Manual On/Off (default), Countdown Timer and Timeclock
	<>	Move to next menu item
<i>for group function only</i>		
Lights Group Filter: Unaffected	+ -	Options available depend on the function that is selected
	<>	Move to previous/next menu item or next configuration menu
<i>for all functions except dimmer relay, super chlorinate pH dispense, low speed, and group</i>		
Lights Freeze Disable	+ -	Toggle between Enabled and Disabled (default) Lights Freeze
	<>	Move to previous/next configuration menu

Lights Name

The Pro Logic allows you to assign any one of a number of names (e.g. “Pool Light, Spa Light, Deck Light, etc.) to this control function. Note that other lights may be assigned to other Aux outputs. This will make the Pro Logic much more user friendly to the homeowner when they want to turn various lights on or off. A sheet of small name labels is included with the Pro Logic main unit and each remote display/keypad so that the “Lights” pushbutton

Flow Monitor

This feature will help protect the filter pump from damage due to no flow. When used with a Goldline flow switch, the Pro Logic monitors the state of water flow when the filter pump is on. If no flow is detected for more than 15 minutes, the Pro Logic will shut down the pool pump and the “Check System” LED will indicate an error. The error will be cleared the next time the pump is turned on.

Freeze Protection

Freeze protection is used to protect the pool and plumbed equipment against freeze damage. If freeze protection is enabled and the AIR temperature sensor falls below the freeze threshold (see below), the Pro Logic will turn on the filter pump to circulate the water. If “Pool and Spa” is selected in the Pool/Spa sub-menu (see page 19), the valves will also alternate between the pool and spa every 30 minutes and the filter pump will turn off while the valves are turning. The chlorinator will not operate if freeze protection is the only reason the pump is running.

Freeze Protection Speed

This menu only appears if freeze protection is enabled and the pump is configured for 2-speed or variable speed pump operation. This is the speed that the pump will run at during freeze protection operation. Select high (default) or low speed operation.

Freeze Protection Temperature

Select the temperature to be used for freeze protection. Temperature is adjustable from 33°F - 42°F (1°C - 6°C). 38°F (3°C) is default. This threshold will be used for all outputs that have freeze protection enabled.

<i>if “Pool & Spa Dual” is selected</i>		
Spa Filter Config. + to view/change	+	Push to access Spa Filter options
	<>	Move to previous/next configuration menu item
Spa Filter Pump 1 Speed	+ -	Rotates between 1-speed (default), 2-speed and variable speed options
	<>	Move to next menu item
<i>if “Variable Speed” is selected</i>		
Lowest Speed 10%	+ -	Adjust the lowest speed desired for variable speed operation
	<>	Move to next menu item
<i>if “Variable Speed” is selected</i>		
Highest Speed 100%	+ -	Adjust the highest speed desired for variable speed operation
	<>	Move to next menu item
Freeze Protect Enabled	+ -	Toggle between Enabled (default) and Disabled Freeze Protection
	<>	Move to next menu item or previous/next configuration menu
<i>if “Freeze Protect” is enabled and “1-speed Filter” is not selected</i>		
Freeze Protect High Speed	+ -	Toggle between high speed (default) and low speed
	<>	Move to next menu item

Spa Filter Pump

For 2-speed pumps: When a 2-speed pump is configured, one of the AUX relays must also be configured to control the low speed motor winding on the pump. Refer to the appropriate sections in the Installation manual for specific information regarding the control logic for 2-speed and variable speed pump operation.

For the Hayward Tristar variable speed pump: The Filter relay is used to supply input power to the VSC pump control. The Filter relay is used to supply input power to the VSC pump control. The relay will be on when the filter pump output is on. When the filter pump output is off, the relay will be off. On, Off and speed is controlled by commands sent to the pump.

Lowest Speed

This is the lowest speed that the variable speed pump is allowed to run at. It is used as the lower limit in the Spa Low Speed Settings Menu. Set lowest speed from 10% (default) to 50%.

Highest Speed

This is the highest speed that the variable speed pump is allowed to run at. It is used as the upper limit in the Spa High Speed Settings Menu. Also, this is the speed that the pump will run during the first 3 minutes of operation anytime the pump has been off for more than 30 seconds. Set highest speed from 20% to 100% (default).

Freeze Protection

Freeze protection is used to protect the spa and plumbed equipment against freeze damage. If freeze protection is enabled and the AIR temperature sensor falls below the freeze threshold (selectable in Filter Configuration Menu - page 21), the Pro Logic will turn on the spa filter pump to circulate the water.

Freeze Protection Speed

This menu only appears if freeze protection is enabled and the pump is configured for 2-speed or variable speed pump operation. This is the speed that the pump will run at during freeze protection operation. Select high (default) or low speed operation.

NOTE: Heater1 and Heater2 configuration are identical. If Heater2 is enabled then Valve4 will automatically be disabled due to the fact that they use the same output relay and only 1 function can be assigned to that relay.

Heater1 Config. + to view/change	+ Push to access heater options <> Move to previous/next configuration menu
Heater1 Disable	+/- Toggle between Enabled and Disabled (default) Heater 1 <> Move to next menu item or previous/next configuration menu
<i>if "Heater1" is enabled</i> Heater1 Name Gas Heater	+/- Rotates between all available names <> Move to next menu item
<i>if "Heater1" is enabled</i> Heater1 Cooldown Disabled	+/- Toggle between Enabled and Disabled (default) Heater 1 Cooldown <> Move to next menu item
<i>if "Heater1" is enabled</i> Heater1 Extend Disabled	+/- Toggle between Enabled and Disabled (default) Heater 1 Extend <> Move to previous/next configuration menu
<i>if "Heater1" is enabled and 1-speed filter pump is not selected</i> Allow Low Speed Disabled	+/- Toggle between Enabled and Disabled (default) <> Move to next menu item or previous/next configuration menu

Heater1

If the heater is "Enabled", the heater relay will turn on when the water temperature is less than the desired temperature setting and the filter pump is running. The desired temperature is in the "Settings Menu". If applicable, the homeowner will be prompted to enter separate "pool" and "spa" settings. Depending on the position of the pool/spa suction valves, the proper temperature setting will be used.

Heater Name

The Pro Logic allows you to assign any one of a number of names (e.g. "Gas Heater, Heat Pump, etc.) to each of the heater control functions. This will make the Pro Logic much more user friendly to the homeowner when they want to turn various heaters on or off or set temperatures. A sheet of small name labels is included with the Pro Logic main unit and each

remote display/keypad so that appropriate pushbuttons can be labeled the same as the name that you have assigned.

Heater Cooldown

This feature ensures that the heater cools down before water circulation is stopped. When enabled, the Pro Logic will continue to run the filter pump for 5 minutes after the heater turns off. During this period the filter pump LED will flash and also a "Heater Cooldown, X:XX remaining" message will scroll on the display.

When the filter pump is running and the heater is on: Pressing the "Filter" button once will cause the heater to turn off, but the filter pump will continue to run for heater cooldown (filter LED flashing and message on display). Pushing the filter button a second time will override the heater cooldown operation and turn the filter pump off.

For a Pool/Spa Setup selection of "Pool Only", "Spa Only" or "Pool and Spa-Std", Heater1 and/or Heater2 cooldown affect the filter pump. For "Pool and Spa-Dual", Heater1 is associated with the spa filter and Heater2 with the pool filter.

Heater Extend

If "Enabled", the filter extend logic keeps the filter pump running beyond the normal turn-off time until the pool (or spa) is heated up to the desired temperature setting (see Settings Menu). Heater extend will NOT cause the filter pump to turn on, it will only delay the turn off time when the heater is operating.

For a Pool/Spa Setup selection of "Pool Only", "Spa Only" or "Pool and Spa-Std", Heater1 and/or Heater2 will keep the filter pump running. For "Pool and Spa-Dual", Heater1 will keep the spa filter running and Heater2 will keep the pool filter running.

Allow Low Speed

This menu only appears if the filter is configured for 2-speed or variable speed operation. During default operation, high speed mode is used whenever the heater is on. If Allow Low Speed is enabled, low speed will be allowed even if the heater is on.

Solar Config. + to view/change	+ Push to access solar options <> Move to previous/next configuration menu
Solar Disabled	+/- Toggle between Enabled and Disabled (default) Solar <> Move to next menu item or previous/next configuration menu
<i>if "Solar" is enabled</i> Solar-Extend Disabled	+/- Toggle between Enabled and Disabled (default) Solar Extend <> Move to next menu item
<i>if "Solar" is enabled</i> Solar Priority Disabled	+/- Toggle between Enabled and Disabled (default) Solar Priority <> Move to next menu item
<i>if "Solar" is enabled and "1-speed Filter" is not selected</i> Allow Low Speed Disabled	+/- Toggle between Enabled and Disabled (default) <> Move to next menu item or previous/next configuration menu

Solar

The Solar configuration menu will NOT appear if "Pool and Spa - Dual" has been selected in the Pool/Spa setup menu. If the solar control logic is "Enabled", several additional steps must be taken to ensure proper operation of the solar heating system. If the solar is operated by a valve, then a valve (Valve3 or Valve4) output must be setup for solar logic (page 30). If the solar is operated by a pump, then one of the AUX relays must be set up for solar logic (page 27). Also, the "solar" temperature sensor must be installed. This sensor is typically mounted near the collector array and is used to sense whether sufficient solar heat is available.